

---

# ACCUPRINT

---

**AP30 - 5000 AP30 - 8000**  
**High Resolution Printer**  
**Service Manual**

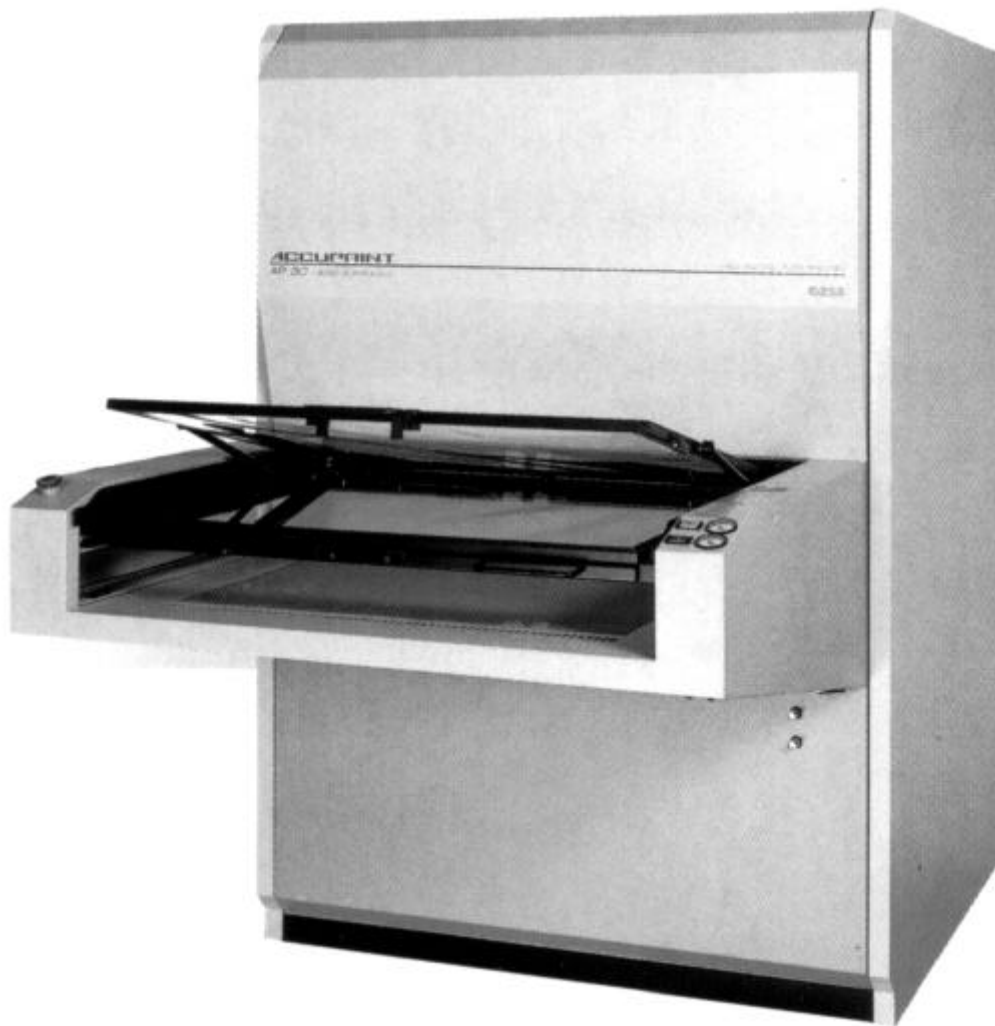

*This manual is designed for technical personnel  
and should only be used by authorized Dealer  
service personnel.*

*This manual is written to provide an  
understanding of the equipment, as well as a plan  
for troubleshooting.*

# 0. Contents

---

## 1. Specifications



Crated dimensions .....	1-1
Shipping weight .....	1-1
Actual dimensions .....	1-1
Effective exposure frame area .....	1-1
Optional reflectors .....	1-2
Intensity .....	1-2
Cooling .....	1-2
Exhaust .....	1-2
Room Air Supply .....	1-2
Water Drain .....	1-2
Electrical specifications and connections .....	1-3
Connecting power .....	1-4

## 2. Integrator Functions and Features

Integrator .....	2-1
Feature Quick Reference .....	2-3
Operator Control Panel .....	2-4
Table Showing the 12 Calibration Positions .....	2-4
Calibration Procedures .....	2-4
Changing the Calibration Number .....	2-6
Matching Exposure Surfaces .....	2-7
Splitting Steps .....	2-8
Matching with a meter .....	2-8

## 3. Integrator Program Set Up

To Enter the Select Mode .....	3-1
Lock Level Feature .....	3-1
Lock Level Description and Operation .....	3-2
Setting or Changing your Lock Code feature .....	3-3
To Clear Lamp Statistics .....	3-3
To Clear Memory and Exposure Statistics .....	3-3
Two Value Exposure Mode .....	3-4
Split Exposure Mode .....	3-4
Single Surface Mode .....	3-5
Board Count Display Mode .....	3-5
Frame Control Interface Mode .....	3-6
Automatic Vacuum Mode .....	3-6
Auto Step Mode .....	3-7
Set Default Vacuum Delay .....	3-7
Tray Mode .....	3-8
Type Mode .....	3-8
Exposure Statistics (Elapsed Hours) .....	3-9
Exposure Statistics (Total Exposures) .....	3-9

	Selecting a Memory Location .....	3-10
	Quick Keypad .....	3-10
	Entering an Exposure Time .....	3-10
	Setting the Light Intensity .....	3-11
	Making an exposure.....	3-11
	Blank frame cycle .....	3-11
	Error Handling System .....	3-12
<b>4.</b>	<b>Diagnostics</b>	
	Output Diagnostics .....	4-1
	Output Functions Check .....	4-1
	Functions Table .....	4-2
	Input Diagnostics .....	4-3
	Typical values that you will see when all switches are good. ....	4-3
	Typical values that you will see when a fault occurs. ....	4-4
<b>5.</b>	<b>Lamp Changing Instructions</b>	
	Lamp Changing Instructions .....	5-1
<b>6.</b>	<b>Preventive Maintenance</b>	
	Preventive Maintenance Daily.....	6-1
	Preventive Maintenance Monthly.....	6-1
	Preventive Maintenance Semi-Annually .....	6-1
<b>7.</b>	<b>Vacuum System</b>	
	Vacuum Pumps .....	7-1
	Flushing the Pump .....	7-1
	Pump Disassembly .....	7-2
	Pump Checkout .....	7-2
	Pump Replacement .....	7-3
	Tubing/Fitting Replacement .....	7-3
	Vacuum Gauge Replacement .....	7-3
	Vacuum Seal Replacement .....	7-4
	Glass Photo Tool (Optional).....	7-6
<b>8.</b>	<b>Nose Assembly</b>	
	Removing the Nose .....	8-1
	Replacing the Display and Keypad P.C.Board .....	8-1
	Replacing the Emergency kz Button .....	8-1
	Replacing the  and  Buttons .....	8-2
	Replacing the Glass Tool Vacuum Buttons.....	8-2
	Replacing the Vacuum Gauges.....	8-2
	Nose Section Autoformer .....	8-2
	Work Lights .....	8-3
	Nose Fans .....	8-3
	Cleaning or Replacing Nose Filters .....	8-3
	Nose Assembly Drawings .....	8-4

<b>9. Exposure Trays</b>	
Mylar® Replacement .....	9-1
If Mylar® Pulls Out of the Frame .....	9-1
Outer Frame Replacement .....	9-1
Tray Assembly Drawing .....	9-3
Mylar Frame Assembly .....	9-5
Gas Strut Removal .....	9-7
Replacing the linear bearings .....	9-7
Frame Glass Replacement .....	9-8
Gas Strut Replacement .....	9-8
<b>10. Center/Drive Assembly</b>	
Center/Drive Assembly Diagram .....	10-1
Frame Transport System .....	10-3
Frame Drive Motor Replacement .....	10-3
Frame Drive Clutch Adjustment .....	10-3
Frame Speed Adjustment .....	10-4
Adjust the 'FAST' pot on the control box. ....	10-5
Light Block Assembly .....	10-6
Replacing Lower Light Block Springs .....	10-7
<b>11. Air Conditioning System</b>	
Compressor .....	11-1
Inlet Filter .....	11-1
<b>12. Diagrams</b>	
Control Box Front View .....	12-1
Control Box Wiring Diagram (Standard with 5kW) .....	12-3
Control Box Wiring Diagram (Standard with 8kW) .....	12-4
Control Box Wiring Diagram (480V all) .....	12-5
Control Box Wiring Diagram (CE all) .....	12-6
Unit Cabling Diagram (old nose) .....	12-7
Unit Cabling Diagram (new nose) .....	12-8
Unit Wiring and Tubing Diagram .....	12-9
Base Assembly Diagram .....	12-10
<b>13. Light Source</b>	
Component Layout .....	13-1
Ballast/Tap Switch Wiring .....	13-5
Interlock System .....	13-8
Lamp Voltage .....	13-9
Lamp Power Path .....	13-9
Trigger Board .....	13-10
Capacitors and Level Switching .....	13-11
Opening the Lamp Head .....	13-15
Shutter .....	13-16
Shutter Switch .....	13-16
Shutter Brake .....	13-16

Shutter Motor .....	13-17
Installing the Motor .....	13-17
Shutter Removal .....	13-18
LT1 Shutter Assembly Drawing .....	13-19
LT8 Shutter Assembly Drawing .....	13-21
Idle Setting .....	13-22
Lamp Head Blowers .....	13-23
Blown Fuse on PC Board .....	13-23
Lamp Head Signals .....	13-24
Light Function States .....	13-25
Printed Circuit Board Layout .....	13-27
Signal Description .....	13-28
Circuit Diagram (64MV407 60Hz) .....	13-30
Lamphead for all Lights .....	13-31
AL 54 Power Supply 60Hz .....	13-32
AL 54-480 Power Supply 60Hz .....	13-33
AL 64 Power Supply 50Hz .....	13-34
AL 84 Power Supply 60Hz .....	13-35
AL 84-480 Power Supply 60Hz .....	13-36
AL 94 Power Supply 50Hz .....	13-37
Interconnect Cable .....	13-38
<b>14. Printing Light Check List</b>	
Check List for Printing Light Troubleshooting and Service .....	14-1
<b>15. Fault Trees</b>	
No Strike Fault Tree .....	15-1
Shutter Rotation Fault Tree .....	15-2
<b>16. Parts List</b>	
Parts List .....	16-1
<b>17. Warranty</b>	
Limited Warranty .....	17-1
Lamp Warranty .....	17-1

# 1. Specifications

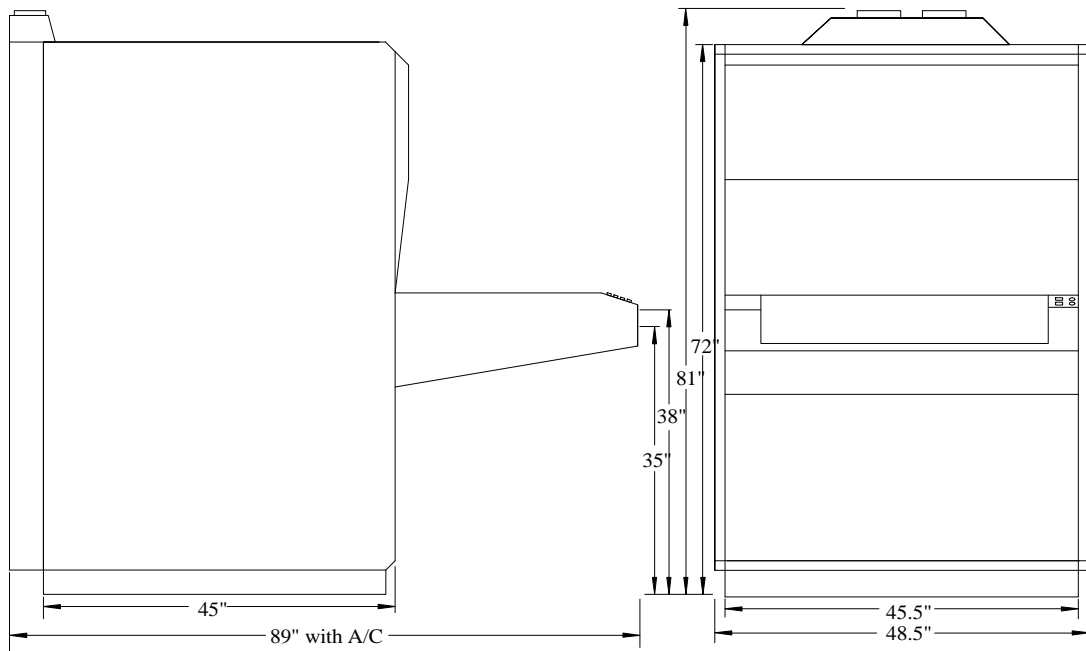

## Crated dimensions

Length	Width	Height
95"	60"	80"
241 cm	152 cm	203 cm

## Shipping weight

Crated	1600 lbs.	727 kg.
Uncrated	1375 lbs.	625 kg.

## Actual dimensions

Cabinet welded heavy gauge steel construction with access doors on both sides.

Length	Width	Height
89"	48.5"	81"
226cm	123cm	206cm

**Note:** The AP 30 - 5000 cannot be disassembled to pass through any doorways or hallways. Please make sure there is adequate room for its passage.

## Effective exposure frame area

Width	30"	76 cm
Depth:	25"	64 cm

### Optional reflectors

Width	24"	61 cm
Depth:	18"	46 cm

### Intensity

	Low	Medium	High
AP 30-5000	1kW	2.5kW	5kW
AP 30-8000	2kW	4kW	8kW

### Cooling

A self-contained air conditioning system is integrated into the rear of the AP 30-5000 / AP 30-8000.

### Exhaust

Two exhaust ducts, diameter 8 in.(203 mm)

To minimize the impact on the working environment, the exhaust must be vented to the outside, a heat exchanger or up through a dropped ceiling.

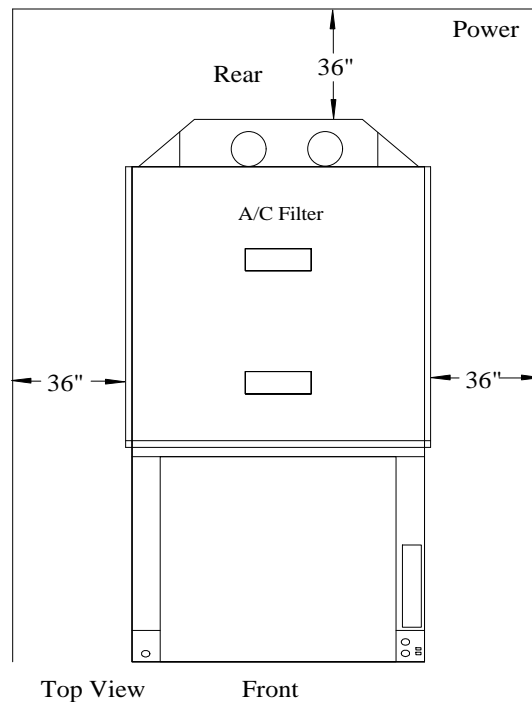

### Room Air Supply

The exposure lamp cooling air is drawn from the exposure room. The ventilation system must be sized to maintain positive pressure in the exposure room for cleanliness and to avoid drawing chemical fumes into the printer.

### Water Drain

A water drain or sump pump is necessary for the air conditioner condensation.



# Electrical specifications and connections

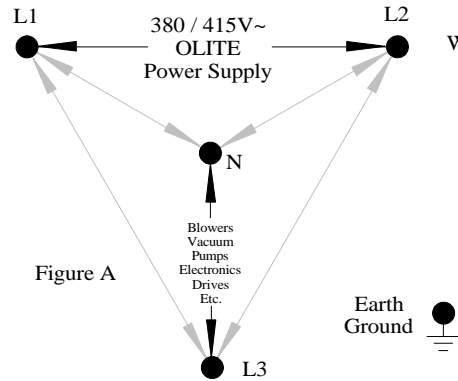

380 / 415V~ 50Hz Connection  
Wye: 3 Wires + Neutral + Ground  
Terminal Block

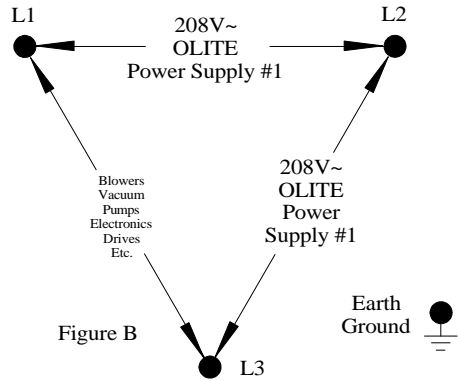
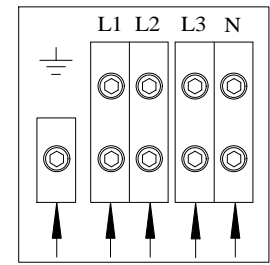

208/240V~ 50Hz Connection  
DELTA: 3 Wires + Ground  
Terminal Block

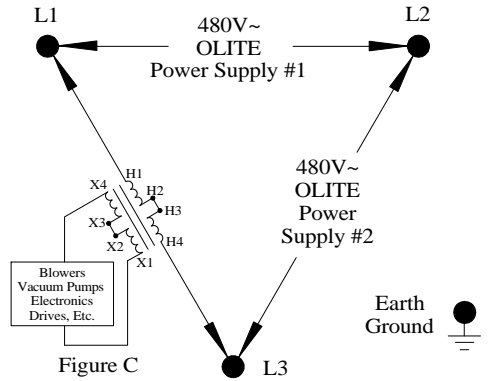
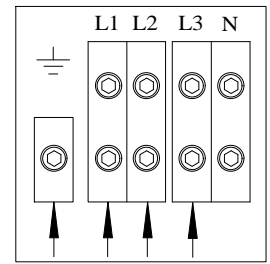

480V~ 60Hz Connection  
DELTA: 3 Wires + Ground  
Terminal Block

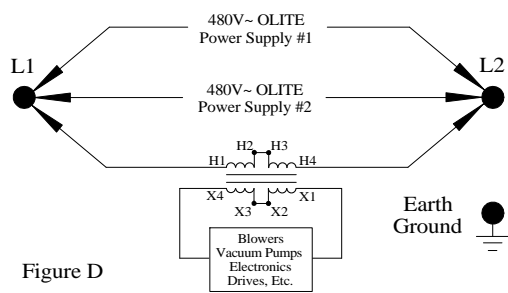
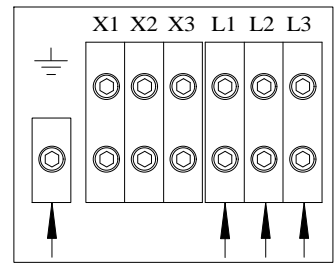

480V~ 60Hz Connection  
Single Phase: 2 Wires + Ground  
Terminal Block

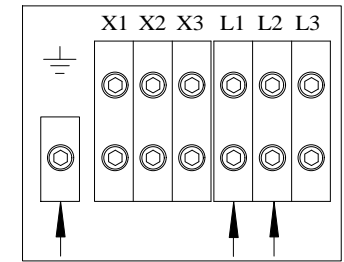

### AP 30 - 5000 printer input

3 phase (Delta)	See Figure C	3 wires + ground	480V~ 60 Hz, 18 amp.
3 phase (Delta)	See Figure B	3 wires + ground	208/240V~ 60 Hz, 44 amp.
3 phase (Wye)	See Figure A	3 wires + neutral + ground	380/415V~ 50 Hz, 24 amp.
Single phase	See Figure D	2 wires + ground	480V~ 60Hz, 35 amp.

### AP 30 - 8000 printer input

3 phase (Delta)	See Figure B	3 wires + ground	208/240V~ 60 Hz, 65 amp.
3 phase (Wye)	See Figure A	3 wires + neutral + ground	380/415V~ 50 Hz, 34 amp.

### Connecting power

- Remove the lower rear panel of the printer by unscrewing the  $\frac{5}{32}$ " Allen head screws that attach it. Remove the two screws from the rear that secure the sliding side doors. Slide both doors to the front.
- Run the main power cord through the round retaining plate on the lower rear center of the printer.
- Connect the main leads to the 4-position terminal block and connect the ground lead to the single ground terminal.
- Energize the main power circuit. You should hear the lamp head and power supply cooling fans go into a cool-down cycle. Ensure that the voltage select switch on the hinged control panel is switched to the lit LED.
- Reinstall the lower rear panel. Make sure the air conditioner drain hose is uncoiled and connected to a drain or allowed to drain into a suitable container.
- Reinstall the side door securing screw.
- Install the lower front and rear black trim pieces over the forklift channels, using a  $\frac{5}{32}$ " Allen wrench.
- Connect two 8" exhaust hoses to the outlets on the top rear of the printer. This will remove the expended heat from the working environment.



**CAUTION** 

PLEASE BE SURE THE DUCT HOSE IS VENTED TO AN OPEN CHAMBER, AS BACK PRESSURE WILL GREATLY REDUCE THE COOLING CAPABILITIES OF THE PRINTER.

## 2. Integrator Functions and Features

Microprocessor-controlled light integrator with LED display, 40 memories, battery backup, single button control, lamp statistics and self-diagnostics. The operator control panel is composed of two sections, the display board and the memory board.

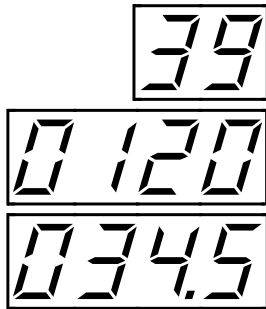

**Note:** The number of digits in each window.

Memory Window

Vacuum Window

Exposure Window

### Integrator

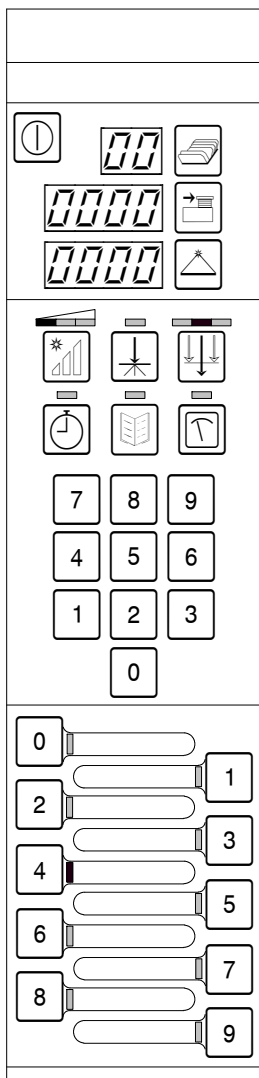

#### **POWER**

Press the power button on the integrator to turn the OV 45/33HD on or off. When the unit is off, the light system blowers will run for about two minutes to cool the lamp.

#### **MEMORY**

Pressing the memory key will advance the memory location. The display will show which memory is selected.

#### **VACUUM**

Press the vacuum key and use the numerical keypad to enter a vacuum delay time. The window shows the delay in seconds.

#### **EXPOSURE**

Press the exposure key and use the numerical keypad to enter an exposure. The window shows the exposure units selected. This key can also be used to move forward through the selectable features in the setup mode.

#### **INTENSITY**

Press this key to select Low, Medium or High power. LEDs lit will indicate the level selected.

#### **DIFFUSER**

Press this key to select the motorized diffuser option.

#### **FILTER**

Press this key to select the motorized filter option.

#### **SECONDS**









Press this key to expose by time, not integrated light units. This key also can be used to move backward through selectable features in the setup mode.

## **MENU**

This key is used as the autostep indicator and for the continuous vacuum feature.

---

### **Note:** **MENU Special Function**

The  key has the optional function to be used to set auto-step and continuous vacuum per memory in normal operating mode. The frame control switch feature must be turned ON and the automatic vacuum feature must be turned OFF. Press the  key the memory window will read  and the exposure window will read . Press the  key to turn auto-step function ON or OFF. Press the  key the memory window will read  and the exposure window will read . Press the  key to turn continuous vacuum function ON or OFF.

---



## **MEASURE**

This key is used to check the lamp intensity.

### - **NUMERICAL KEYPAD**

These keys are used to enter the vacuum time, exposure units, and to access a particular memory location.

### - **INSTANT MEMORY KEYPAD**

The OV 45/33HD has 40 independent memory locations, the first ten of which are on the lower section of the integrator for instant access. There is a space provided to write down the application of these memories. Simply press the lower  through  key that corresponds to the most commonly used applications.

## Feature Quick Reference

The following feature descriptions appear in the exposure window while setting each feature. In order to select or setup the following features you must first be in the setup mode.

The text 'Lock' is displayed in a stylized, outlined font within a rectangular border.

Lock Level Feature

The text 'code' is displayed in a stylized, outlined font within a rectangular border.

Lock Code Feature

The text '2VAL' is displayed in a stylized, outlined font within a rectangular border.

2 (two) Value Exposure Feature

The text 'SPILT' is displayed in a stylized, outlined font within a rectangular border.

Motorized Filter Feature

The text 'SSUR' is displayed in a stylized, outlined font within a rectangular border.

Single Surface Exposure Feature

The text 'bcnt' is displayed in a stylized, outlined font within a rectangular border.

Exposure Count Feature

The text 'FCL' is displayed in a stylized, outlined font within a rectangular border.

Frame Control Switch Feature

The text 'AVAC' is displayed in a stylized, outlined font within a rectangular border.

Automatic Vacuum Feature

The text 'ASTP' is displayed in a stylized, outlined font within a rectangular border.

Auto Step Feature

The text 'dVAL' is displayed in a stylized, outlined font within a rectangular border.

Vacuum Delay Feature

The text 'FRAY' is displayed in a stylized, outlined font within a rectangular border.

Frame Speed Feature



The text 'TYPE' is displayed in a stylized, outlined font within a rectangular border.

System Type Setting Feature

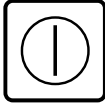



## Operator Control Panel











The AP 30 heavy duty exposure system has a power key on the integrator.

- Press the  key to turn on the unit.
- Press the  key again after use, and the system will run through a 2 minute cool down cycle and then turn off all blowers.

### STOP Button

- Press the  button once. Frame movement will stop.
- Press the  button once more, the frame will return, at slow speed, to the original position and vacuum will turn off.
- Press the  button twice to cancel an exposure.
- Holding the  button down then pressing the  button starts a blank cycle - no vacuum or exposure.

### GO Button





- Press the  button once to initiate vacuum drawdown on the exposure frame.
- Press the  button a second time to move the frame into the unit and start an exposure.
- If frame switch  and auto vacuum  are turned on, press the  button once to move the frame into the unit and start an exposure.
- If frame switch  and auto vac  are turned on, press the  button once without opening the upper or lower frame will start a blank frame cycle - no vacuum or exposure.



---

**Note:** If a vacuum delay  is used, the exposure will not begin until the vacuum delay time has counted down.

---

## Table Showing the 12 Calibration Positions

	Upper Frame, Top Surface
	Upper Frame, Bottom Surface
	Lower Frame, Top Surface
	Lower Frame, Bottom Surface

		
1st	5th	9th
2nd	6th	10th
3rd	7th	11th
4th	8th	12th

## Calibration Procedures

---

**Note:** The AP30 high resolution printer has been calibrated at the factory.

---

**Note:** The following calibration procedures can be applied to all three light intensities, if starting calibration from scratch. To adjust existing calibration set the integrator to 500 mj and make the exposure. Increase or decrease the calibration number the same percentage the 500 mj is off.

---

- Press the  key on the integrator to power up the lights, the front switches, and the printer's computer system.





---

**Note:** Allow the printer a 5 minute warm-up period before any calibration procedures. This will allow for complete and accurate light level stabilization.

---

- Press the integrator  key to select the desired light level to be calibrated, always start at Low Intensity.

For 8kW	Low 2000 W	Medium 5000 W	High 8000 W
For 6kW	Low 2000 W	Medium 3500 W	High 6000 W
For 5kW	Low 1000 W	Medium 2500 W	High 5000 W

- In order to prevent possible damage to the high resolution printers Mylar® while calibrating we recommend you set the no vacuum feature.
- Press the  key on the keypad, the Memory and Exposure windows will dim.
- Press the  key three times.
- Press the  key once. This will prevent vacuum while calibrating. The Vacuum window will read .
- The high resolution printer's calibration has been set at the factory.



Upper frame top surface



Upper frame bottom surface



Lower frame top surface





Lower frame bottom surface

---

**Note:** Preset all 12 calibration factor numbers to 500 units. Place a slim UV meter facing up on the center of the top frame, below the Mylar®.

---

- Enter a 500 unit exposure into the integrator. Be sure the seconds mode is off.
- Press the  button twice. This will send the frame into the unit and start the exposure.
- After the exposure, retrieve your frame by holding down the  button and press  button. When the frames start to move, release both buttons.
- Record the resulting mj reading from the meter.

---

**Example:** Let's say our 500 unit exposure gave us 600 mj. That means we got 1.2 mj per unit or a 1.2:1 ratio. The objective is to get a 1:1 ratio. To get that we would multiply our current calibration number of 500 by 1.2,  $500 \times 1.2 = 600$ .

---

- Since we are working with the Upper Tray Top Surface or  $\overline{UT}$ , we have to change the preset 500 to 600.
  - Change to 600 as described earlier in Calibration Procedures Section.
- 

**Remember:** The lower the CAL number, the longer the exposure and the higher the mj reading.

---

- Now make a 500.0 unit exposure with the UV meter and record the resulting mj reading. It should be  $500 \pm 3\%$ . Perform this procedure on the remaining three surfaces.



Press  $\overline{1}$ ,  $\overline{2}$ ,  $\overline{3}$  then  $\overline{4}$  on the numerical keypad. The Vacuum window will read  $\overline{500}$ . This places you in select mode.

- Press the  $\overline{\text{CAL}}$  key once and press the  $\overline{0}$  key to clear, then  $\overline{\text{CAL}}$  key, then the  $\overline{0}$  key to activate the vacuum after being turned off earlier in this procedure.

### Changing the Calibration Number

- Press the  $\overline{\text{CAL}}$  key on the integrator. The Memory window will read  $\overline{UT}$ , the Exposure window will show the existing calibration number for the top surface of the upper frame at the selected intensity.
  - Press the  $\overline{\text{SEL}}$  key to select frame surface ( $\overline{UT}$ ,  $\overline{UB}$ ,  $\overline{LT}$ ,  $\overline{LB}$ ).
- 

**Remember:** For top frame calibration use  $\overline{UT}$  and  $\overline{UB}$  and for bottom frame calibration use  $\overline{LB}$  and  $\overline{LT}$ . Also, the larger the calibration number the faster that surface will count and the less accumulated energy will result on the frame.

---

- Enter the new calibration number on the desired surface by pressing  $\overline{\text{CAL}}$  key to open the program, then use numerical keypad.
- 

**Example:** To change  $\overline{UT}$  from 500 to 650 simply press  $\overline{6}$ ,  $\overline{5}$ ,  $\overline{0}$ ,  $\overline{0}$ .

---

- Press the  $\overline{\text{CAL}}$  key to close the program.
- Press the  $\overline{0}$  key twice to return to the operating mode.



## Matching Exposure Surfaces

- Do a test exposure in the frame being calibrated to the reference frame.
- Determine the correction necessary to make each surface the same at the reference surface. If this is done with a step scale the correction is as follows.

.15 Density Scale	
Step	Correction
-2.00	0.50
-1.75	0.55
-1.50	0.60
-1.25	0.65
-1.00	0.71
-0.75	0.77
-0.50	0.84
-0.25	0.92
0.00	1.00
0.25	1.09
0.50	1.19
0.75	1.30
1.00	1.41
1.25	1.54
1.50	1.68
1.75	1.83
2.00	2.00

.05 Density Scale	
Step	Correction
-2.00	0.79
-1.75	0.82
-1.50	0.84
-1.25	0.87
-1.00	0.89
-0.75	0.92
-0.50	0.94
-0.25	0.97
0.00	1.00
0.25	1.03
0.50	1.06
0.75	1.09
1.00	1.12
1.25	1.15
1.50	1.19
1.75	1.22
2.00	1.26



Press , ,  then  on the numerical keypad. The Vacuum window will read . This places you in select mode.

- Then press the  key and the exposure window will show previous calibration number. There is a separate number for each intensity. Select the intensity to be adjusted with the  key.

Read the current calibration number and multiply it times the correction. For example if you double the calibration number, the integrator will count twice as fast consequently the exposure energy will be cut in half.

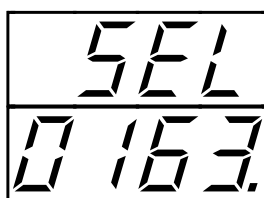

Press , ,  then  on the numerical keypad. The Vacuum window will read . This places you in select mode.

Then press the  key and the exposure window will show previous calibration number. (for example ).

- Press the  key, the memory window will dim and you will be able to enter the new calibration number by pressing the new number into the key pad.

## Splitting Steps

A densitometer can be used to assist in determining a fractional difference in step scales. When measuring density, make several measurements to avoid being influenced by pinholes.

### Example

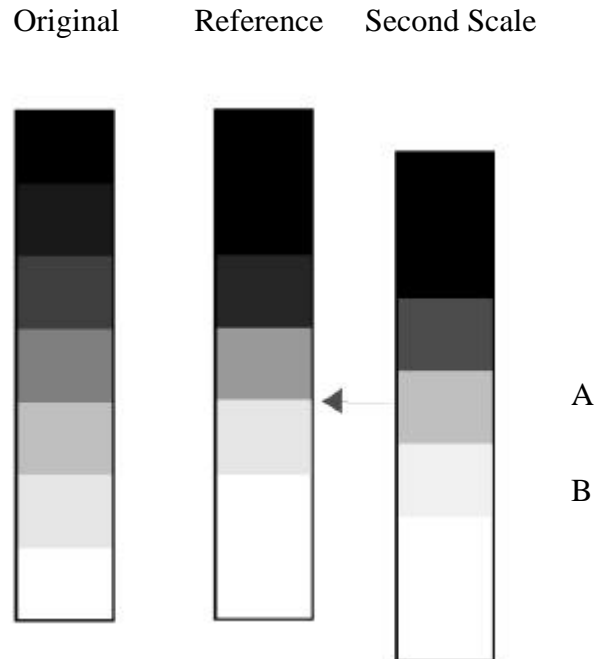

- Pick a step from the reference with a density greater than .15 and less than 2.0.
- Find the steps on the second scale that straddle the first. In the example the reference is .30, step "A" is .24 and step "B" is .40.  $(\text{Ref.} - \text{A}) / (\text{B} - \text{A}) = .06 / .16 = .375$ . The example step is .375 steps under the reference.

### Matching with a meter

If an integrating meter is available that has a photocell that matches the film, it can be used to match the surfaces. We recommend that the results be verified on film.

- Make a reading on the reference surface and then the surface to be adjusted.
- Divide the reading on the surface to be adjusted by the reading from the reference surface.
- Multiply the current calibration number by the result above.

### 3. Integrator Program Set Up

---

#### To Enter the Select Mode





---

**Note:** This step must be followed in several of the program set ups.

---



- Press the  key on the integrator to power up the light, the front remote switches, and the exposure unit's computer system.

Press , ,  then  in sequence. The Vacuum window will read . This places you in the select mode.

#### Lock Level Feature

The lock levels are provided to keep operators from accessing any features and functions that should be left alone. There are five different lock levels available. Lock levels 1 - 3 allow the locking of individual memory locations, while lock levels 0 and 4 apply to all of the memory locations.

- Level 0 - No locks. Most of the features and functions can be accessed by any operator.
- Level 1 - Locks functions per memory (seconds, exposure, vacuum, intensity, filter, diffuser) to prevent accidental changes to these settings. Locks on individual memories may be turned ON and OFF without the need to enter a code.
- Level 2 & 3 - Locks functions per memory similar to lock level 1, except once lock is turned ON for a particular memory, it may not be turned OFF again without entering the lock code. Also locks the parameters on the set up menu so they cannot be changed without entering the lock code.
- Level 4 - Locks all functions. A code is required to change any operating parameters.





---

**Note:** You *must* ensure the lock level is set to 0 before continuing with the Integrator Program Set Up Features and the exposure memory options detailed below in Lock Level Description and Operation. When programming is completed return to Lock Level Feature and set the desired lock level.

---







- Press the  key on the integrator to power up the light, the front remote switches, and the exposure unit's computer system.

Press , ,  then  in sequence. The Vacuum window will read . This places you in the select mode.

Press the  key once, the Exposure window will read .

- Press the  key once.
- If the Lock Level is set at 0 or 1 the Memory and Exposure windows will

dim. Enter the lock level desired.

- Press the  key to set entry.
- If the Lock Level is set for 2, 3 or 4, the Exposure window will read . Enter your 3 digit code.
- Press the  key.
- Press the  key.
- Press the  key.

---

**Note:** If you want a higher Lock Level after you have completed the Integrator Program Set Up and/or made any changes return to Lock Level Feature and set the lock level described in Lock Level Description and Operation).

---



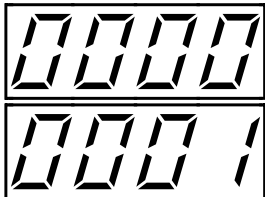

### Lock Level Description and Operation



#### Lock Level 0



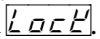



The Vacuum window will read .

#### Lock Level 1

The Vacuum window will read . Locks functions for seconds, enter, vacuum and intensity per memory. Once this mode is turned ON and the set up programing has been completed, enter all needed information into a memory location. Then press the  key, the Memory window will read  and the Exposure window will read . Press the  key to turn the lock for this memory ON or OFF, then press the  key. When the lock is turned ON, a decimal point will be displayed after each digit in the Memory window.



#### Lock Level 2, 3

The Vacuum window will read  or . Locks functions for seconds, enter, vacuum and intensity per memory and Integrator Program Set Up Features. Before this mode is turned ON, enter all needed information into a memory location. Then press the  key, the Memory window will read  the Vacuum window will read  and the Exposure window will read . Press the  key to turn the lock ON or OFF for this memory. When the lock is turned ON a decimal point will be displayed after each digit in the Memory window. Once this level is turned ON you will not be able to unlock the features described above without the Lock Code. See Setting or Changing your Lock Code Feature.



#### Lock Level 4

The Vacuum window will read . This locks all functions. When the lock is turned ON, a decimal point will be displayed after each digit in the Memory window. Once this level is turned ON and the set up programing has been completed, before you can change any programmed features or the exposure statistics you must use the Lock Code to set the Lock Level back to 0, see Setting or Changing your Lock Code Feature.

## Setting or Changing your Lock Code feature

---













**Note:** If you are setting the code you must know the existing code.

---

**Note:** Lock Level *must* be set to 0 to program this step and reset when finished see Lock Level feature.

---

A rectangular display showing the characters 'SEL' in a stylized, outlined font.A rectangular display showing the characters 'code' in a stylized, outlined font.



- Press the  key on the integrator to power up the light, the front remote switches, and the exposure unit's computer system.  
Press , ,  then  in sequence. The Vacuum window will read . This places you in the select mode.
- Press the  key once. The Memory window will read .  
Press and release the  key until the Exposure window reads .
- Press the  key the Memory and Exposure windows will dim. Enter your new 3 digit code
- Press the  key to set entry.
- Press the  key twice to exit this mode.

### To Clear Lamp Statistics



**CAUTION** This step clears all lamp statistics explained in sections Lamp Statistics.

---









**Note:** You can abort clearing the lamp statistics by pressing the  key before the display counts down to  and you will not change any memory and exposure statistics.

---

**Note:** Lock Level *must* be set to 0 to program this step and reset when finished, see Lock Level feature.

---

A rectangular display showing the characters 'SEL' in a stylized, outlined font.



- Press the  key on the integrator to power up the light, the front remote switches, and the exposure unit's computer system.  
Press , ,  then  in sequence. The Vacuum window will read . This places you in the select mode.
- Press the  key five (5) times.
- Press the  key once to exit this mode.

### To Clear Memory and Exposure Statistics



**CAUTION** This step clears all information stored in the memory.

---

**Note:** You can abort clearing the memory by pressing the  key before the display counts down to  and you will not change any memory and exposure statistics.

---



- Press the key on the integrator to power up the light, the front remote switches, and the exposure unit's computer system.  
Press , , then in sequence. The Vacuum window will read . This places you in the select mode.
- Press the key five (5) times.
- Press the key once to exit this mode.

### Two Value Exposure Mode

---

**Note:** The two value mode enables the operator to run a different job or resist on each frame. With this feature turned ON, a value entered in the Vacuum window becomes an exposure value. For instance, if you enter 800 in the Vacuum window and 450 in the Exposure window, during an exposure both surfaces on the upper frame will receive 800 mj while both surfaces on the lower frame will receive 450 mj. To activate this option:

---



- Press the key on the integrator to power up the light, the front remote switches, and the exposure unit's computer system.  
Press , , then in sequence. The Vacuum window will read . This places you in the select mode.
- Press the key once. The Memory window will read .
- Press and release the key until is displayed in the Exposure window.
- Press the key to cycle mode ON or OFF.
- Press the key twice to exit this mode.

### Split Exposure Mode

The split exposure mode works in conjunction with the previously mentioned two value mode. It enables the user to select separate exposure values for the upper and lower surfaces of each frame, in case different exposures are required for each surface of the panel. An exposure can be entered in the center display which will be used on the top surface of each frame and a separate exposure value can be entered in the lower display which will be used on the bottom surface of each frame.

---

**Note:** The two value mode MUST be selected ON for the split exposure mode to function.



---



- Press the key on the integrator to power up the light, the front remote switches, and the exposure unit's computer system.  
Press , , then in sequence. The Vacuum window will read . This places you in the select mode.
- Press the key once. The Memory window will read .

The image shows the word "SPILT" in a stylized, outlined font, enclosed in a rectangular border.

Press and release the e key until SPILT appears in the Exposure window. This places you in the split exposure option.





- Press the  key to cycle the split exposure mode ON or OFF.
- Press the  key twice to exit this mode.

### Single Surface Mode

The printer may be programmed to use the top light only, the bottom light only, or both lights. For exposing phototools or single sided exposures, you may want to use only one light. Each of the 40 memories is independent, to allow for any combination you wish on a particular memory. While programming:

- Press the  key on the integrator to power up the light, the front remote switches, and the exposure unit's computer system.



The image shows the word "SEL" in a stylized, outlined font, enclosed in a rectangular border.

Press , ,  then  in sequence. The Vacuum window will read SEL. This places you in the select mode.



- Press the  key once. The Memory window will read 5u.

The image shows the word "SSUR" in a stylized, outlined font, enclosed in a rectangular border.

Press and release the e key until SSUR appears in the Exposure window. This places you in the single surface mode.

- Press the  key to turn the single surface option ON or OFF.
- Press the  key twice to exit this mode.

---

**Note:** Press the  key to activate feature in operating mode so that the Memory display reads RL and the Exposure display reads [SURF]. Press the  key to select bottom bot, top top or both both. Now press the  key. If you have selected both lamps, the left memory digit is complete and means upper and lower lamps are selected. If you have top lamp only, the left memory digit displays upper segment only and means only the upper lamp is selected. If the left memory digit displays lower segment only it means only the lower lamp is selected.

---

### Board Count Display Mode

The printer will constantly display all the exposure information. With the board count display option turned ON, the Vacuum window will show a running total of the number of exposures that have taken place. This can be very useful in verifying that all exposures were made for a particular job.

---

**Note:** It is recommended to leave this feature OFF when the two value or split features are activated. To activate the board count display option:

---

- Press the  key on the integrator to power up the light, the front remote switches, and the exposure unit's computer system.



Press , ,  then  in sequence. The Vacuum window will read . This places you in the select mode.

- Press the  key once. The Memory window will read .
- Press and release the e key until  appears in the Exposure window. This places you in the board count option.
- Press the  key to cycle the board count ON or OFF.
- Press the  key twice to exit this mode.

### Frame Control Interface Mode

The frame control interface works in conjunction with each frame's magnetic switch. If either frame is open, motorized transport will not function. This prevents inadvertent frame movement with the outer frame open. It is recommended that this safety feature be turned ON at all times. In the event of a switch failure or a unit without switches, it can be bypassed.

---

**Note:** This safety feature will always be ON unless you turn it OFF. To deactivate the frame control interface mode:

---

- Press the  key on the integrator to power up the light, the front remote switches, and the exposure unit's computer system.
- Press , ,  then  in sequence. The Vacuum window will read . This places you in the select mode.
- Press the  key once. The Memory window will read .
  - Press and release the e key until  appears in the Exposure window. This places you in the frame control interface mode.
  - Press the  key to cycle the frame control interface mode ON or OFF.
  - Press the  key twice to exit this mode.



### Automatic Vacuum Mode

The automatic vacuum mode allows the printer to start vacuum automatically by closing the frame. If a preset vacuum delay is used, such as default vacuum delay, the center display will show the vacuum countdown. The  button then only needs to be pressed once to start frame movement. With this feature turned ON, a blank frame cycle will be initiated simply by pressing the  button once when the frame has not been opened. To activate this option:



- Press the  key on the integrator to power up the light, the front remote switches, and the exposure unit's computer system.
- Press , ,  then  in sequence. The Vacuum window will read . This places you in the select mode.
- Press the  key once. The Memory window will read .







Press and release the e key until **AVAL** appears in the Exposure window. This places you in the automatic vacuum option.



- Press the  key to cycle the automatic vacuum mode ON or OFF.
- Press the  key twice to exit this mode.

### Auto Step Mode

---

**Note:** This feature allows you to run a series of exposures in sequence.





---

**Note:** If Auto Step is selected, the LED over the  key will indicate if the feature is ON or OFF. If ON, press the  key to turn it OFF.

---

- Press the  key on the integrator to power up the light, the front remote switches, and the exposure unit's computer system.





Press , ,  then  in sequence. The Vacuum window will read **SEL**. This places you in the select mode.

- Press the  key once. The Memory window will read **5W**.





Press and release the  key until **ASTP** appears in the Exposure window. This places you in the autostep option.

- Press the  key to cycle the Auto-Step mode ON or OFF.
- Press the  key twice to exit this mode.

### Set Default Vacuum Delay

---

**Note:** This feature is used to provide sufficient vacuum drawdown time before exposure. The time begins when the frame lid is closed with the **AVAL** turned ON, or when you press the  button for the first time. If you press the  button again before the vacuum delay counts down, the frame will move into the cabinet, but the exposure will not start until the time is completed.





---

**Note:** This default delay time will be ignored if a delay time other than 0 has been programmed into the memory location being displayed.

---

- Press the  key on the integrator to power up the light, the front remote switches, and the exposure unit's computer system.





Press , ,  then  in sequence. The Vacuum window will read **SEL**. This places you in the select mode.

- Press the  key once. The Memory window will read **5W**.



Press and release the  key until the Exposure window reads **AVAL**.

- Press the  key and enter the time you wish the vacuum turned ON before the exposure begins. The time you selected has now been programmed for all memories.
- Press the  key twice to exit this mode.

## Tray Mode



### CAUTION

The default tray speed is set at the factory to 5 seconds. OLEC does not recommend changing this setting without consulting the OLEC factory. Damage to the transport can occur.

- Press the key on the integrator to power up the light, the front remote switches, and the exposure unit's computer system.  
Press , , then in sequence. The Vacuum window will read . This places you in the select mode.
- Press the key once. The Memory window will read .
- Press the key until appears in the Exposure window.
- Press the key once. The Vacuum window will read and the Exposure window will read . If lock mode was turned ON, enter your code now, then press the key, (If the lock code has never been changed *section 4.3*, the default code is 000).
- Enter the time you wish to have the tray speed set for. For example, for a 5.0 second travel time, press , and then press the key again the Memory window and Exposure window will return to normal brightness.
- Press the key twice to exit this mode.

## Type Mode



### CAUTION

The type has been set at the factory and should not be changed. Proper operation of the unit will be affected if changed.

- Press the key on the integrator to power up the light, the front remote switches, and the exposure unit's computer system.  
Press , , then in sequence. The Vacuum window will read . This places you in the select mode.
- Press the key once. The Memory window will read .
- Press the key until appears in the exposure window. This places you in the System Type option.
- Press the key once. The Vacuum window will read and the Exposure window will read . If lock mode was turned ON, enter your code now, then press the key, (If the lock code has never been changed, the default code is 000).  
  
Press the V key to cycle the Vacuum window to read [AP30]. This setting applies to both the AP30 5kW and AP30 8kW, air conditioned and closed loop models.
- Press the key twice to exit this mode.

## Exposure Statistics (Elapsed Hours)

---

**Note:** The exposure statistics should be reset to zero when the lamps are changed.





---

**Note:** This provides the operating hours on the lamps in total and at each intensity since the last reset. This function should be used whenever the exposure lamps are replaced.



---

- Press the  key on the integrator to power up the light, the front remote switches, and the exposure unit's computer system.



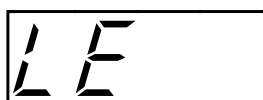

Press , ,  then  in sequence. The Vacuum window will read . This places you in the select mode.





Press the  key. The letters  will appear in the Vacuum window. The Exposure window will display the exposure time, in seconds, of the last exposure, regardless of its memory position or intensity.





Press the  key a second time, the letters  will appear in the Vacuum window. The total elapsed time, in hours, that the unit has been ON will be displayed in the Exposure window.





Press the  key a third time. The letters  will appear in the Vacuum window. The elapsed time, in hours, that the lamp has been used at medium power will show in the Exposure window.



Press the  key a fourth time. The letters  will appear in at the Vacuum window. The elapsed time, in hours, that the lamp has been used at low power will show in the Exposure window.



Press the  key a fifth time. The letters  will appear in the Vacuum window. The elapsed time, in hours, that the lamp has been used at high power will show in the Exposure window.

- Press the  key twice to exit this mode.

## Exposure Statistics (Total Exposures)

---

**Note:** To find out how many exposures your system has made since the last reset.





---

**Note:** The exposure statistics should be reset when the lamps are changed.

---

- Press the  key on the integrator to power up the light, the front remote switches, and the exposure unit's computer system.



Press , ,  then  in sequence. The Vacuum window will read . This places you in the select mode.



Press the  key. The letters  will appear in the Vacuum window. The Exposure window will display the number of exposures made at high power.

Press the  key a second time. The letters  will appear in the Vacuum window. The Exposure window will display the number of exposures at low power.

Press the  key a third time. The letters  will appear in the Vacuum window. The number of exposures at medium power will be displayed in the Exposure window.

- Press the  key twice to exit this mode.

### Selecting a Memory Location

- Press and release the  key on the operator control panel to cycle through the 40 memory locations (0-39).
- You may go to a particular memory by entering the desired memory number on the numerical keypad on the integrator.

**EXAMPLE:** Enter a desired memory number, e.g. 12. Press the corresponding keys,  then  on the numerical keypad, then press the  key.

### Quick Keypad

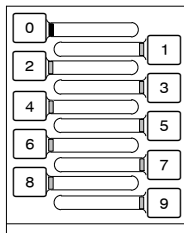

Instant access by pressing any of the memory locations from 0 to 9.

### Entering an Exposure Time

Press the  key on the integrator.

---

**Note:** The Memory and Vacuum windows will dim.

---



Enter desired exposure time by depressing corresponding number on keypad. For example , , ,

- Press the  key to confirm the entry.

## Setting the Light Intensity

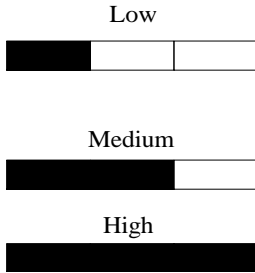

- Press the key to set intensity. Press for the first time. The first LED on the left indicates the intensity is set to low ( 1kW on 5kW units, 2kW on 8kW units).
- Press: I for the second time. The first two LEDs light to indicate the intensity is set to medium ( 2kW on 5kW units, 4kW on 8kW units ).
- Press: key for the third time. All three LEDs light to indicate the intensity is set to high (5kW on 5kW units, 8kW on 8kW units ).

**Optional:** Press the key to set for time or integrate mode. The LED ON indicates a timed exposure and OFF an integrated exposure.

---

**Note:** During operation, ensure that the mode is OFF.

---

## Making an exposure

Place material in the exposure frame and close the frame.

- If and options are turned ON, vacuum will start automatically when the frame is closed. If and are OFF, press the button to start vacuum. The upper or lower vacuum gauge will indicate the vacuum level for the appropriate frame.
- Examine both sides of the frame to check the vacuum drawdown visually.
- When good vacuum contact is assured, press the button to move the frame into the cabinet and start exposure. If second frame has been examined press the button and the frame will go into the cabinet (The frames will not move if the previous exposure is still in progress.)
- Remove the material from the frame that was previously exposed and repeat for the next exposure.
- To stop the frame after it has started moving, press the button once. To retrieve it, press again, or to continue with the exposure, press the button. The frame will move in at a slower speed.

## Blank frame cycle

To change frame position with no vacuum or exposure:

---

**Note:** If is turned ON and you do not open the frame, press the button and the frame will move in without vacuum or exposure.

---



Front right arm of operator control panel

- Press and hold the button.
- Press the button.
- Release both buttons when the frames start moving

## Error Handling System

If an error occurs, the machine displays an error code to aid in troubleshooting. The error codes defined are:



The message  will appear in the Vacuum window, and a number in the Exposure window. Look up the number below for a description of the condition.

Description



Frames did not reach intended position after the maximum amount of time.

Solution: Determine why. Were the frames moving at all? Did they get close? Is something obstructing their movement?

See I/O test mode for instructions on how to test motors and switches.

Not used.



Internal error. Please call your service rep.

Solution: Cycle the power switch.

Please note the circumstances under which this error occurred; was the machine exposing? Calibrating? Idle? Were new exposure values being entered? What was the last button pressed? How long ago?



Frames not in position at start of exposure.

Solution: Put the frames in position by cycling the power switch. If the frames don't move, check the wiring to the frame motor and the frame position sensing switches. If everything is OK, and this error still occurs, call your service representative. See also the I/O test mode description.



Switch error. The machine thinks both frames are at the exposure position.

Possible causes are: Bad cable between master board and memory board, switches have failed, bad or no connection to switches.



Communication error. Remote board is not communicating with the master board.

Possible causes are: no power to remote board, bad or disconnected communication cable.



Remote board has reset or temporarily lost power. After clearing the error, normal function should continue.



At least one lamp intensity/frame/surface has not been calibrated.

Solution: Ensure the unit has been completely calibrated.

## 4. Diagnostics

---

### Output Diagnostics

One of the many advancements OLEC has introduced to the field is the ability of its equipment to run a self-diagnostic check. All computer-activated functions and all internal and external switches can be checked out on the integrator display by using the numerical keypad.

### Output Functions Check



- Press the  key on the integrator to power up the light, the front remote switches, and the exposure unit's computer system.

Press , , , then  in sequence. The Vacuum window will read . This places you in select mode.

- Press the  key to enter the Diagnostics mode. The number in the Vacuum window will be the sum of all values for peripherals that are turned On.



Press the  key to reset the Diagnostics mode. This turns Off all peripherals. Therefore the Vacuum window will indicate .

- Refer to the Functions Table.
- Press the number key to actuate the desired function. The numerical value shown in the table should appear in the Vacuum window.
- Press the function key number again to turn off the function. Press the  key to turn off all functions.
- Press the  key twice to return to normal operation.

## Functions Table

△	Function	Value
1	A/C Compressor On/Off	0001
2	A/C Blower On/Off	0002
3	Upper Vacuum Pump On/Off	0004
4	Lower Vacuum Pump On/Off	0008
5	Work Light and Nose Section Fans On/Off	0016
6	Motor Direction Control	0032
7	Frame Motor On/Off	0064
8	Motor Fast/ Slow	0128
9	All controls off	0000
0	Return to Select mode	SEL

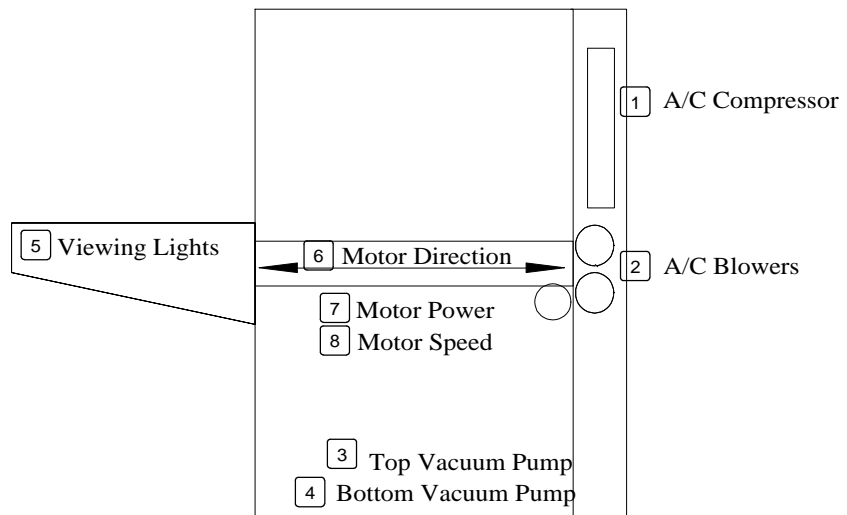



## Input Diagnostics



- Switch Check  
The switch check can be done while in the Select mode.
- Press the key on the integrator to power up the light, the front remote switches, and the exposure unit's computer system.  
Press , , , then in sequence. The Vacuum window will read . This places you in select mode.
- Press the key. The Exposure window on the integrator will show various numbers as the switches or keys are closed.

**Examples:** With the upper frame moved in, the side access door switches closed, and the key pressed on the nose section, the lower integrator display should read . With the lower frame in, the display should read .

	DOOR	FRAME SWITCH	FRAME	NUMBER DISPLAYED
128	+32	+4	+1	=  (Upper Frame In)
128	+32	+4	+8	=  (Lower Frame In)

- Switch Table

Switch Value	Function
1	Upper frame in (labeled "frame")
4	Frame switch
8	Lower frame in (labeled "frame")
16	key, nose section
32	Door/emergency  switch
128	key, nose section

### Typical values that you will see when all switches are good.

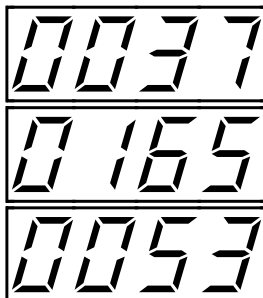

- Upper tray in, Frame switch closed, Door and Emergency switches closed.  
The bottom display should read .
- When the button is pushed the value should change to .
- When the button is pushed the value should change to .



- Lower tray in, Frame switch closed, Door and Emergency switches closed.  
The Exposure window should read 0044.



When the  button is pushed the value should change to 0172.



When the  button is pushed the value should change to 0060.

**Typical values that you will see when a fault occurs.**







Indicates neither frame in position, magnetic frame switches closed, and does not have the correct reading from either the door switches or emergency  button.



Indicates upper frame in position, magnetic frame switches closed, and does not have the correct reading from either the door switches or emergency  button.



Indicates lower frame in position, magnetic frame switches closed, and does not have the correct reading from either the door switches or emergency  button.

- Whatever the switch value display reads when the  button is pressed and the value does not increase by a value of 128 the  switch is bad.
- Whatever the switch value display reads when the  switch is pressed and the value does not increase by a value of 16 the  switch is bad.

## 5. Lamp Changing Instructions



**WARNING** The lamps and safety glass may be very hot and cause burns. Prior to changing the lamp, ensure the lamp head is turned off and allowed to complete its cooldown cycle.

OLEC recommends that every year you unplug your light, remove the safety glass, and clean the glass and reflector with denatured alcohol and a soft cloth. Lamps should be checked for excessive exposure times and should be replaced if exposure time has become too long.

- Support the safety glass on the lamp head and loosen the two thumbscrews to release the glass. Carefully slide the holding brackets up or down. The safety glass will slide from either side of the lamp head.
- Loosen the thumbscrews for both lamp wire spade lugs.
- Disconnect and remove the lamp by removing the spade lugs and wires from under the thumbscrews.
- Carefully lift each end of the lamp (one end at a time) out of the holders and remove the lamp from the lamp head.

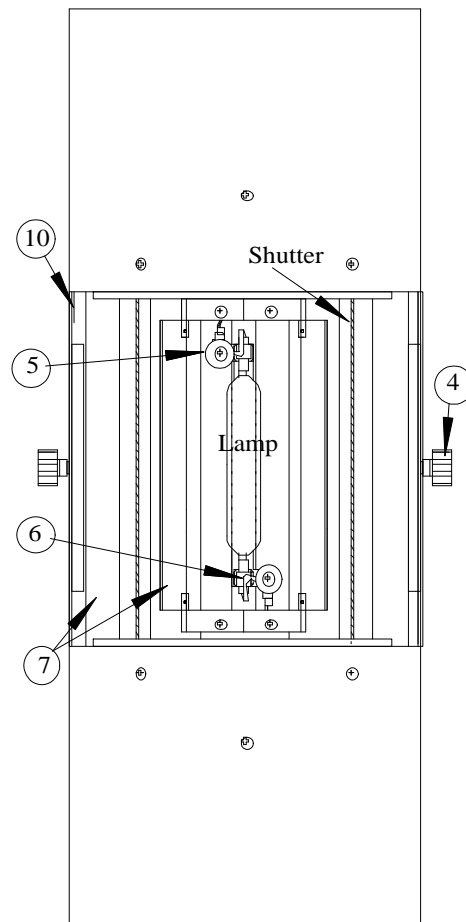

- Clean the reflector with a mild solvent, such as denatured alcohol, and a clean soft cloth. Use glass cleaner to clean the safety glass. Dirty

reflectors and glass can substantially reduce light output.

- Wear the white lightweight fabric gloves that are provided and unpack the new lamp. Clean the lamp with the alcohol wipe included.
- Place each end of the new OLITE lamp (one end at a time) on the holders. DO NOT touch the lamp with your hands. Contamination of the quartz tube of the lamp with skin oils will shorten the life considerably and may lead to failure.
- Reconnect the lamp by fully inserting the spade lugs on the connecting wires under BOTH thumbscrews and tighten. Ensure the wires are positioned so they do not touch the lamp body or the reflector and cooling tube.
- Insert the safety glass into the holders and push against the housing. Ensure the safety interlock lever is positioned firmly underneath the glass towards the lamp and not squeezed to the side. Also, ensure the safety glass is loose enough to allow for heat expansion during an exposure. The light will not operate unless the safety glass is installed properly. When the safety glass is properly installed, it will be able to move slightly. If the safety glass is installed too tight, it may be damaged during use.

---

**Note:** OLITE Lamps are specifically designed for OLEC and undergo careful testing and preparation before shipment. They carry the OLEC Warranty of Satisfaction. Substitutes and copies of lamps are not approved by OLEC, nor do they carry our Warranty. Use approved OLEC replacement parts ONLY!

---

## 6. Preventive Maintenance

---

### Preventive Maintenance Daily (Approximately 15 minutes required)

- Clean exposure frame glass and Mylar. The exposure frame glass and Mylar should be kept meticulously clean. Dirt and resist flakes on these surfaces will cause exposure defects.
- Inspect Mylar for cuts and tears. Check the condition of the Mylar on both exposure frames. The film should be clear and free of holes, creases, and scratches. Replace the Mylar whenever necessary. Replacement procedures are in the Service section of this manual.
- Inspect exposure frame vacuum seals for cracks. Check the condition of the inner and outer rubber seals on the frame glass. Cuts or nicks in the seals could cause vacuum leaks and slow frame evacuation. Replace the seals as necessary. Replacement procedures are in the Service section of this manual.

### Preventive Maintenance Monthly (Approximately 1 hour required)

Perform daily maintenance steps plus the following:



**CAUTION**

Do not use silicone spray lubricants in the printer.

- Lightly oil frame tracks. Lightly oil the upper and the lower exposure frame tracks every month. Wet a small piece of cloth or paper towel with a lightweight machine oil and rub it on the linear bearing surface. Keeping the linear bearings oiled will ensure smooth and quiet operation.



**CAUTION**

Do not use silicone spray lubricants in the printer.

- Lubricate gas strut mounts. Apply a light coat of oil on the retaining ball mountings for the gas struts that support the upper half of each exposure frame.

### Preventive Maintenance Semi-Annually (Approximately 2 hours required)

Perform daily and monthly maintenance steps plus the following:

- Clean unit and power supplies. The inner cabinet and power supply areas should be cleaned to prevent dust buildup.
- Turn the printer off and allow the internal blowers to run through their cool-down cycle. Disconnect the power and lock it out.
- Open both side cabinet doors. Remove both power supply covers by removing the two top forward screws and lift the covers up and forward. Using a vacuum or compressed air, remove all accumulated dust and debris from the cabinet and the power supplies.
- Clean reflectors and lamp head safety glass. Clean the lamp reflectors and the safety glass on the upper and lower lamp heads. Refer to the lamp replacement procedures in the Service section of this manual for disassembly information.



**CAUTION** Do not use silicone spray lubricants in the printer.

- Lubricate frame drive chain and check tension.
- Apply a light coat of machine oil to the exposure frame drive chain by rubbing an oil wetted rag along the chain. Do not wet the chain enough to cause the oil to run or drip.
- The chain tension adjustment is along the inner left hand side of the nose section. Turning the adjuster nut clockwise tightens the chain; counterclockwise loosens it. Adjust the chain to allow no more than a 1 inch (25 mm) flex between the drive motor and the adjuster wheel.



**CAUTION** Do not use silicone spray lubricants in the printer.

- Lubricate upper and lower light block mechanisms. Apply a light coat of machine oil to the piano-style hinges on the on the upper and lower light blocks. Apply a light coat only otherwise excess oil will drip on the exposure frames during operation.
- Clean vacuum pump filters. Remove and clean the filters in each vacuum pump. Replace the filter if plugged with debris. Refer to “Vacuum System” in the Service section of this manual for more detailed information.



**CAUTION** Do not use silicone spray lubricants in the printer.

- Lubricate frame latches. Apply a small drop of light machine oil to each of the four frame latches.

## 7. Vacuum System

---

### Vacuum Pumps

#### Description:

The printer uses two 1/4-hp oilless rotary vane vacuum pumps, one for each exposure frame. Pressing the GO button on the front nose assembly activates the pump for frame that is out of the cabinet. The vacuum gauge on the front panel indicates which pump is activated.

#### Pump Construction:



**CAUTION** This is an oilless vacuum pump; it should never be lubricated. The pump end plate, body, rotor, and mounting bracket are cast iron. Consequently, any moisture that accumulates in the pump will corrode the interior, especially if it stands idle. The muffler box on the front of the unit is made of aluminum.

- The vanes are hard carbon and are precision ground. They should last many thousands of hours, depending upon the degree of vacuum or pressure at which the pump is run. The carbon vanes and grease-packed motor bearings require no oil.

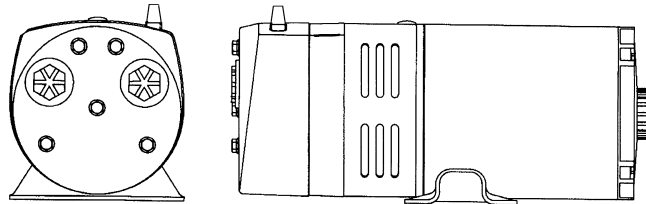

- Filtration: Be certain that dirt, chips, and other foreign material, often found in new plumbing, is not allowed to enter the pump. Liquid, moisture vapor, or oil-based contaminants will affect pump performance and must be prevented from entering the pump. Dirty filters restrict air flow and, if not corrected, could lead to motor overload, poor performance, and early pump failure. Check the filters semi annually or when necessary. The filters can be dried with compressed air. Filters should be cleaned or replaced every 1500 to 3000 hours, depending on the application.

#### Flushing the Pump



**WARNING** Wear eye protection and flush the pump in a well-ventilated area. Do not use kerosene or other combustible solvents to flush the pump. Use Gast AH 255 flushing solvent or its equivalent. If excessive dirt, foreign particles, moisture, or oil enter the pump, the vanes will act sluggish or may even break. Flushing the pump should remove these materials. There are two options for flushing the pump.

### Flushing Option #1

This option requires two pipe nipples at least 4" (102 mm) long with  $\frac{3}{8}$ " NPT threads on one end.

- Remove the filter elements from the front of the muffler box and screw the nipples into the same holes.
- With the pump running, allow about 2 tbsp. of flushing solvent to be ingested into the vacuum side of the unit.
- Repeat the flushing procedure. If it does not correct and clear the pump, remove the end plate for further examination.

### Flushing Option #2

- Remove the filter elements from the front of the muffler box.
- Carefully remove the five bolts that hold the muffler box in place (be careful not to damage the gaskets). Tap the box with a small hammer to break it loose.



#### CAUTION

**Prying with a screwdriver will damage the gasket.** This will allow access to the intake and exhaust ports.

- Follow through with steps 2 and 3 for Flushing Option #1.

### Pump Disassembly

Pump disassembly is required if flushing does not remove the foreign materials.

- Disconnect the power to the pump motor.
- Remove the six bolts holding the end plate to the body.
- Remove the end plate and the four vanes (do not remove the rotor or loosen any electric motor through-bolts).
- The vanes could be worn or only require further cleaning. The top clearance (between rotor and body) may be adjusted by:
- Loosening the body bolts.
- Lightly tapping on the pump body and turning the rotor, while setting this clearance, to assure that all points on the rotor clear the body.

### Pump Checkout

If the pump does not activate when the  button is pressed, see the Diagnostics section, then:

- Ensure that the exposure frame is in its full outward position.
- Check for  switch continuity at the switch connector. The switch harness connector is under the nose assembly, where it meets the front bulkhead.
- Check if the vacuum pump LED is lit at the control box. If so, check for voltage at the pump. If voltage is present at the pump connector, but the pump fails to operate, replace the pump. If the control box LED is not on, check the wiring and connections from the switch to the control box.



## **Pump Replacement**

Vacuum pump replacement is straightforward. The left-hand pump controls the lower frame; the right-hand pump controls the upper frame. (Left and right as viewed by the operator.)

- Open either the left or right side cabinet door, depending on which pump is to be replaced.
- Disconnect the vacuum tubing from the pump. Push the outer ring on the connector and pull the vacuum tubing out.
- Disconnect the in-line electrical pump connection located approx. 6" from the motor end of the pump.
- Remove the four 1/2" nuts that secure the pump mounting plate to the isolation mounts. Then lift the pump out of the unit.
- Remove the mounting plate from the defective pump and install it on the new pump.
- Note the wire positions and remove the electrical harness from the defective pump and install it on the new pump.
- Install the new pump in reverse order of removal and verify the correct operation and rotation.

## **Tubing/Fitting Replacement**

If a vacuum line or connection is cracked, loose, leaking or broken, replace it as soon as possible. A faulty vacuum line or connection will greatly increase the vacuum drawdown time required, if not eliminate full vacuum altogether. All vacuum lines are separated from the connectors by pressing down and holding the connection outer ring while pulling the vacuum line out. To replace the vacuum line into the connections, simply push the line all the way into the connection.

## **Vacuum Gauge Replacement**

See section Nose Assembly.

## Vacuum Seal Replacement

A cut, torn or otherwise damaged vacuum frame seal will greatly inhibit, if not prevent, full vacuum. A bad seal can be lifted and peeled off the frame glass. If necessary, use a razor blade or other suitable item to remove any leftover seal adhesive. Install the new seal as shown in Figure 1.



### CAUTION

If using a razor blade or any other sharp object, be careful not to damage or scratch the glass. It is **VERY IMPORTANT** to not stretch the seal as it is being placed onto the frame glass.

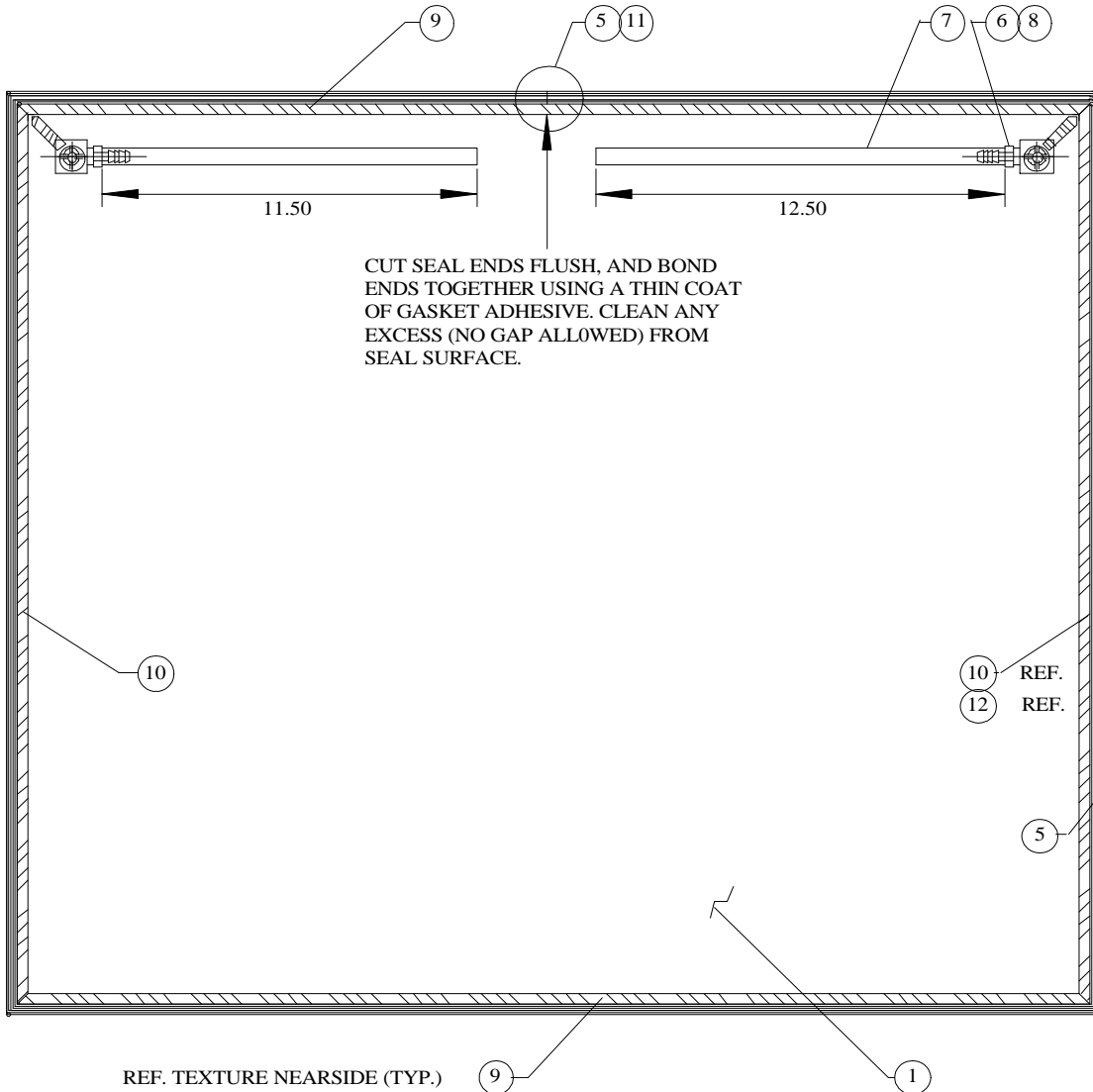

ITEM	QTY.	DESCRIPTION	PART NO.	ITEM	QTY.	DESCRIPTION	PART NO.
1	1	GLASS, AP30D	18D1734A00	8	1	TAPE, TEFLON SEALANT	81TAP12
2	2	VACUUM BLOCK	12D1738A71	9	2	STRIP, FRONT & REAR	13D2213A99
3	2	INTAKE PORT	12D1728A62	10	2	STRIP, R.H. & L.H. SIDE	13D2214A99
4	4	O-RING Ø.50 I.D.	44ORNG01	11	1	GASKET ADHESIVE	82ADH11
5	11'	SEAL, "WAVE" SHAPE	44GKT13	12	11'	TAPE, TRANSFER	81TAP09
6	2	HOSE ADAPTER	44ADT03	13	2	STRIP, CORNER	13D3006A00
7	1'	TUBING, CLEAR VINYL	49DCT24				

## Vacuum Seal Replacement (cont.)

- Unless otherwise specified

Dimensions are in inches.

Dwg. per ANSII Y14.5

Tolerances are: Angles  $\pm 5$  deg.  $.X \pm 1$   $.XX \pm .03$   $.XXX \pm .010$   
 $.XXXX \pm .0030$ .

- Clean glass perimeter. Press transfer tape onto glass. (as shown) Trim tape along edge of glass. Peel off paper.
- Peel off paper from seal, press seal onto transfer tape. Align seal with outside edge of glass.



**CAUTION** Do not stretch seal. Cut 90° notch, see Detail B. Use a seal miter cutting tool.

- Continue peeling off paper from seal, bend 90° and press seal onto transfer tape while aligning seal with outside edge of the glass.



**CAUTION** Do not stretch seal.

- Press ABS strip, items 9&10, onto transfer tape, align with seal. Clean any excess transfer tape along inside edge. Press transfer tape onto back of short ABS strip. (Item 13) Peel paper off tape and align as shown.

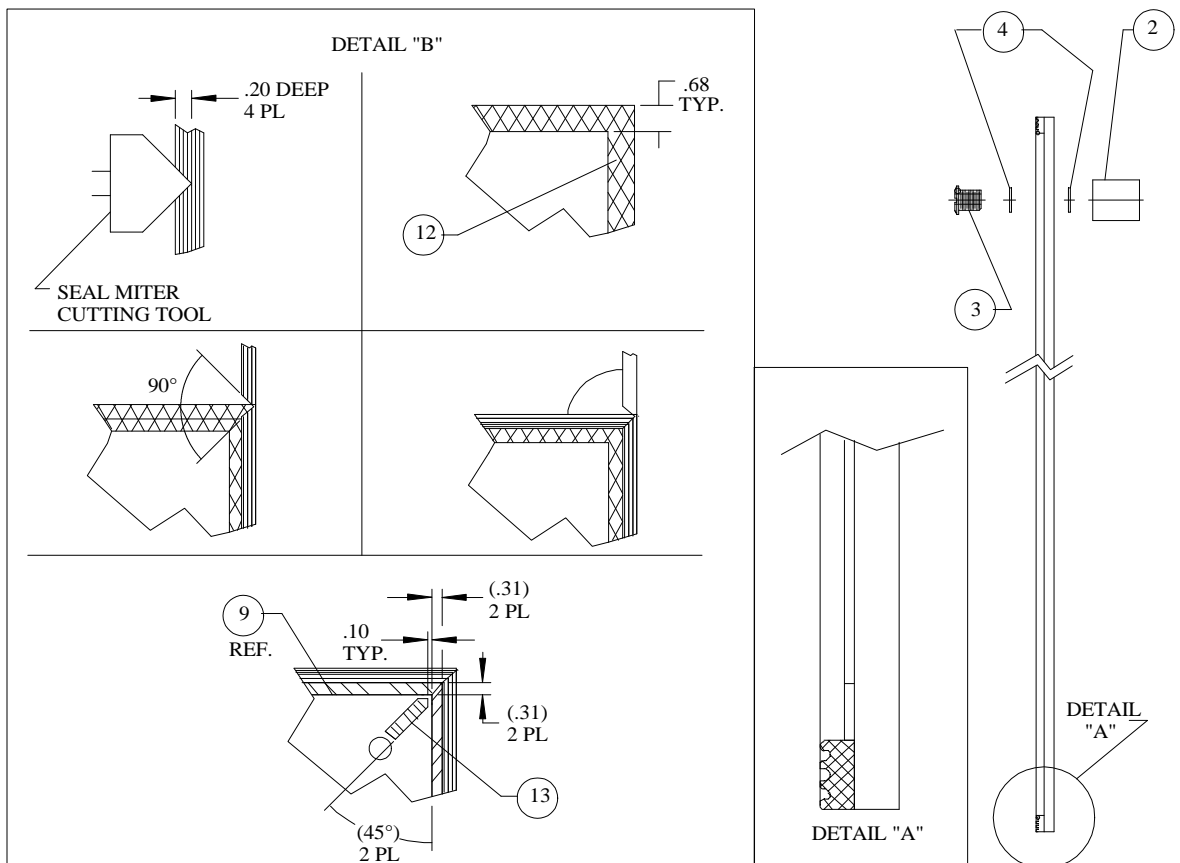

## Glass Photo Tool (Optional)

- If the unit is equipped with the Glass Photo Tool Option you will have a third vacuum pump installed in the bottom of the unit..
- See section Vacuum Pumps and section Tubing/Fitting Replacement for vacuum problems.
- The vacuum pump used for the glass tool is independent of the integrator and is used to hold the art work to the glass tool. The operation of the pump is controlled by the buttons on the left front on the nose of the unit.
- The button labeled \*xpump must be pressed to turn on the vacuum pump.
- Once the pump has been turned on then the button for the upper tool or lower tool can be pressed to activate the respective solenoid in order to hold the art work to the glass tool.
- Several different glass tools are available according to customer needs so each tool itself is going to be different, however the electrical wiring and operation is the same.
- Wiring Diagram for Glass Photo Tool Option

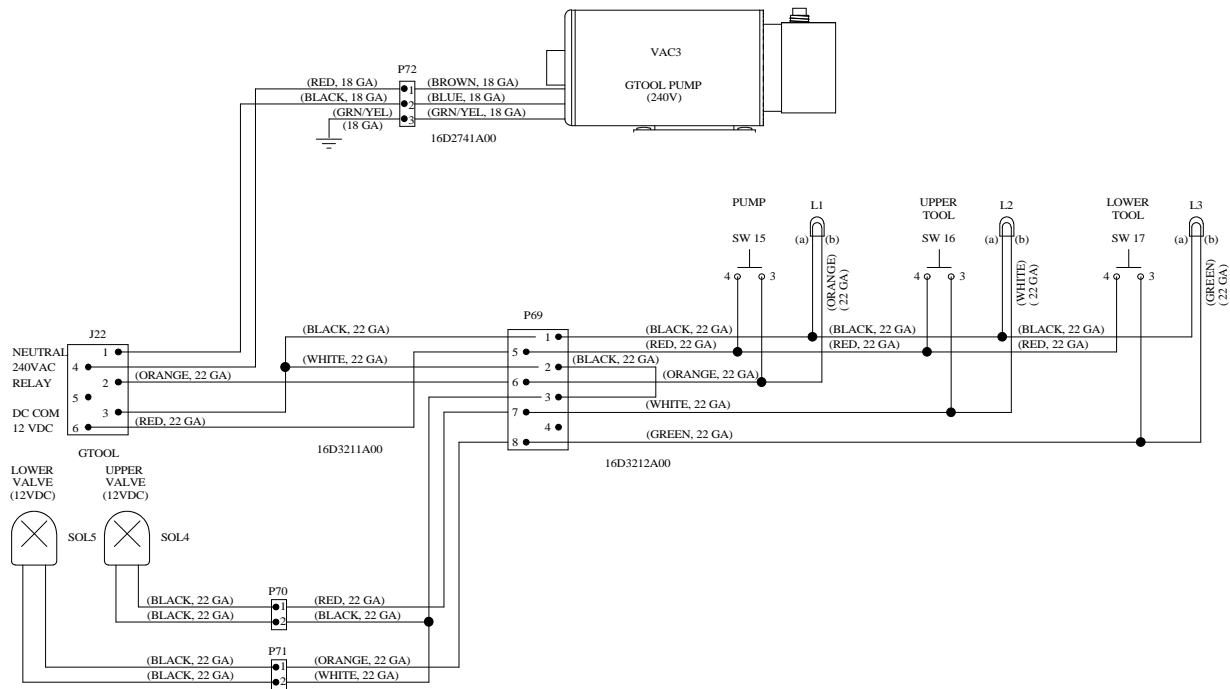

## 8. Nose Assembly

---

### Removing the Nose

- Turn unit off, allow the unit to complete its cool down cycle and disconnect power.
- While standing in front of the unit locate and disconnect all multi-pin connectors and vacuum lines below the nose on the right side.

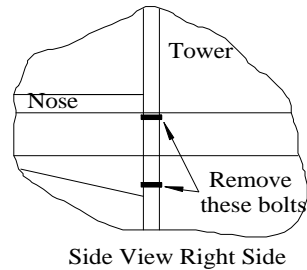

---

**Note:** It may be necessary for one person to be working from the inside of the unit and one person working from outside the unit unless you completely remove the door.

---

- Locate the four  $\frac{7}{16}$ " hex bolts (two on each side) holding the nose to the main tower. On older models these bolts are accessed through a clearance hole in the tower structure. Remove all four bolts.
- Carefully slide the nose piece out as far as needed or off of the structure.
- Reassemble in reverse order.

### Replacing the Display and Keypad P.C.Board

- Remove the nose (see section Removing the Nose) and place it on carpet or any surface that will not damage the keypad overlay or the paint.
- Remove the 6 nuts holding the Keypad and the 4 nuts from the Quick Keypad along with all the plug in connectors. Cut any tie straps holding wiring harnesses soldered to the boards in order to remove them.
- Install the new p.c.boards in reverse order and reassemble the nose.

### Replacing the Emergency Button

- Slide the nose out (see section Removing the Nose) but it is not necessary to completely remove it, the nose just needs to be slid out far enough to access the switch.
- Disconnect the plug on the back of the switch base.
- Remove the two screws from the bottom of the switch base.
- While holding the top of the button twist the switch base to separate the switch into two pieces and remove it from the nose.
- Install the new switch in reverse order.

## Replacing the and Buttons

- Slide the nose out (see section Removing the Nose) but it is not necessary to completely remove it, the nose just needs to be slid out far enough to access the switches.
- Use a small screw driver inserted between the switch and the sheet metal to break the glue holding the two black retainer clips on each side of the switch from the nose.
- Press together the switch retainer clips on the base of the switch and push the switch out the top and replace wire for wire onto the new switch.
- Install in reverse order, Put a drop of super glue on each retainer clip to hold it to the nose.

## Replacing the Glass Tool Vacuum Buttons

- Remove the nose (see section Removing the Nose) and place it on carpet or any surface that will not damage the keypad overlay or the paint.
- Disconnect and mark the wires on the back of the switch base.
- Remove the two screws from the bottom of the switch base.
- While holding the top of the button unscrew the switch base to separate the switch into two pieces and remove it from the nose.
- Install the new switch in reverse order.

## Replacing the Vacuum Gauges

- Remove the nose (see section Removing the Nose) and place it on carpet or any surface that will not damage the keypad overlay or the paint.
- Remove the vacuum tubing from the gauge.
- Remove the gauge retaining bracket and the faulty vacuum gauge.
- Install in reverse order.

## Nose Section Autoformer

---

**Note:** The work lights and nose fans receive their power from this autoformer, if both the fans and the work lights are not working check this autoformer first.

---



- Remove the nose (see section Removing the Nose)
- Meter input and output of the autoformer from 0 to 240, 0 to 208 and 0 to 120. If defective replace.

## Work Lights

---

**Note:** The work lights are controlled by a rocker switch on the underside of the right front corner of the nose. If the work lights are not turning on check the rocker switch and power to the switch. The work lights receive their power from the autoformer in the nose section

---

- To change the lamps the trays must first be moved to the center position, this is done by:
- Press and hold the  button.
- Press the  button.
- Release both buttons when trays start moving.
- Just before the trays reach the center turn the power off.
- Lift the diffusion cover off of the light assembly.
- Twist the lamp to disengage it from the socket and remove it.
- Install in reverse order.

## Nose Fans

---

**Note:** The nose fans are controlled by a rocker switch on the underside of the right front corner of the nose. If the nose fans are not turning on check the rocker switch and power to the switch.

---

- Remove the nose (see section Removing the Nose).
- Disconnect the power leads to the blower(s).
- Remove the blower(s).
- Install in reverse order.

## Cleaning or Replacing Nose Filters

- Slide the filters toward the front of the unit and out of the brackets.
- Clean metal filters with water or environmentally safe solvent.

## Nose Assembly Drawings

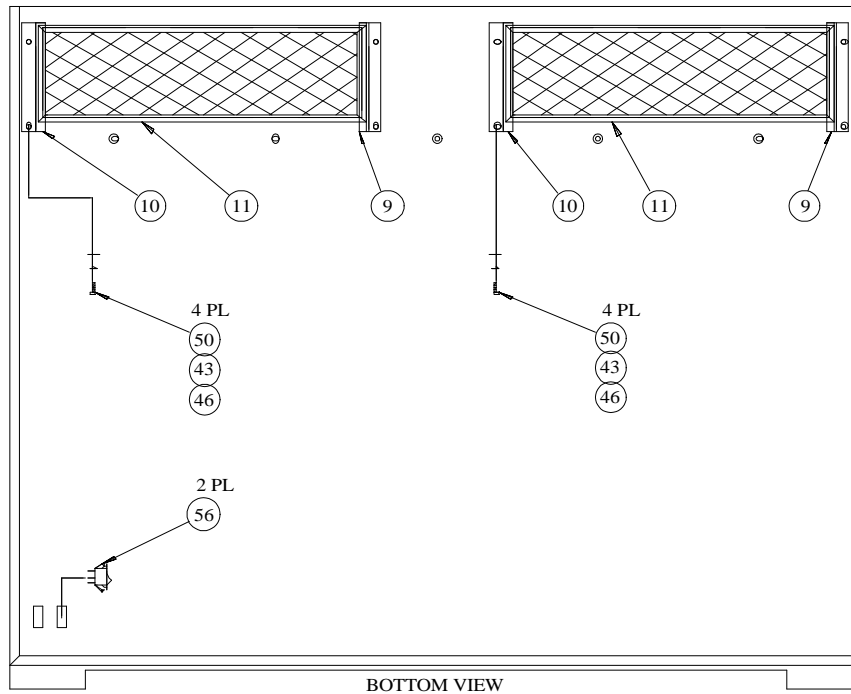

58	10	NSI 6-32 KEP NUT ZINC	41-06NKP	29	1	HARNESS, SW, OPERATOR OV45	16D2196A00
57	10	6-32 X .312 HEX THD. SPACER	44HHS9292	28	-	REMOVED	REMOVED
56	2	SWITCH, CW	55SW01	27	1	EMERGENCY PUSHBUTTON ACTUATOR	55SW53
55	3"	TRIMLOCK	44TRM02	26	4	BARRIER	55SW45-5
54	4	NSI 8-32 X 3/8 PPMS ZINC	41-08PPS.37	25	1	BUTTON, YELLOW "STOP"	55SW45-2
53	10	NSI #6 INTERLOCK LOCK WASHER	41-06WLI	24	1	BUTTON, GREEN "GO"	55SW45-1
52	8"	TAPE, TEFLON SEALANT 1/2"	81TAP12	23	2	SWITCH, NOSE AP30/33	55SW45
51	4	NSI #10 FLAT WASHER SAE	41-10WFR	22	1	ASSEMBLED SUPPLEMENTAL KEYBOARD	64MI477
50	8	NSI 6-32 X 3/8 PHIL PAN MS BLK	41B06PPS.37	21	1	KEYBOARD FOR OV45	64MI478
49	3	NSI CABLE TIE 4" #18 MAX	44TIE02	20	2	VACUUM GAUGE, 0-30"-1-1/2" DIA.	49VAG02
48	3	TIE WRAP ADHESIVE MOUNT BASE	44PAD03	19	80"	TUBING, NYLON 1/4" OD-.180 ID	49DCT27
47	2	1/4-20 LOCKNUT NYLON	41B40NLN	18	1	5 POSITION TERMINAL STRIP OV24	52TS05
46	16	NSI #6 FLAT WASHER SAE	41-06WFR	17	2	LIGHT FIXTURE UNDERCABINET 24"	39CLF02
45	6	NSI #8 FLAT WASHER, SAE	41-08WFR	16	2	BLOWER	39BLO11
44	8	NSI 1/4 SAE FLAT WASHER	41-40WFR	15	2	LAMP, YELLOW VIEWING 20 WATT	35LMF06
43	16	NSI #6 SPLIT LOCK WASHER	41-06WLS	14	1	AUTOFORMER, 120/208/240V50/60Hz	32TRC03
42	6	NSI #8 SPLIT LOCK WASHER	41-08WLS	13	1	OVERLAY, RAIL COVER, AP30	15D2270A00
41	8	NSI WASHER, SPLIT LOCK 1/4	41-F0WLS	12	1	BEZEL, WORKLIGHT, 2 LAMP	18D2430A00
40	2	NSI 8-32 KEP NUT ZINC	41-08NKP	11	2	FILTER, TOP AP30	19D1942A99
39	4	NSI 10-32 KEP NUT ZINC	41-12NKP	10	2	BRACKET, FILTER HOLDER (RHT)	11D1939B62
38	2	NSI 8-32 X 3/4 PPMS ZINC	41-08PPS.75	9	2	BRACKET, FILTER HOLDER (LFT)	11D1939A62
37	4	NSI 10-32 X 1/2 PPMS ZINC	41-12PPS.50	8	2	BRACKET, NOSE SUPPORT	11D1791A02
36	8	NSI 6-32 X 1/2 BLK SELF TAP	41B06PST.50	7	1	AIR DIRECTOR No.3- NOSE	11D2438A08
35	16	NSI 8-32 X3/8 PFMS 100-ZINC	41-08PFO.37	6	1	AIR DIRECTOR No.2- NOSE	11D2433A08
34	14	NSI 6-32 X 3/8 PHIL PAN MS BLK	41-06PFO.37	5	1	AIR DIRECTOR No.1- NOSE	11D2427A08
33	6	1/4-20 X 5/8 SOCKET BTN HD BLK	41BF0SHC.62	4	1	DIVIDER, NOSE AP30 RIGHT	11D2426B62
32	4	ADHESIVE SQUARE 4026	44PAD02	3	1	DIVIDER, NOSE AP30 LEFT	11D2426A62
31	2	CONNECTOR, TUBE 3/8 TO 1/4 OD.	43FIT14	2	1	REFLECTOR, WORK LT. AP30	11D3255A07
30	1	HARNESS, EMERGENCY SWITCH	16D2412A00	1	1	RAIL COVER, AP30	11D2425A00
ITEM	QTY	DESCRIPTION	PART NO.	ITEM	QTY	DESCRIPTION	PART NO.

Continued on next page



### Nose Assembly Drawings (cont.)

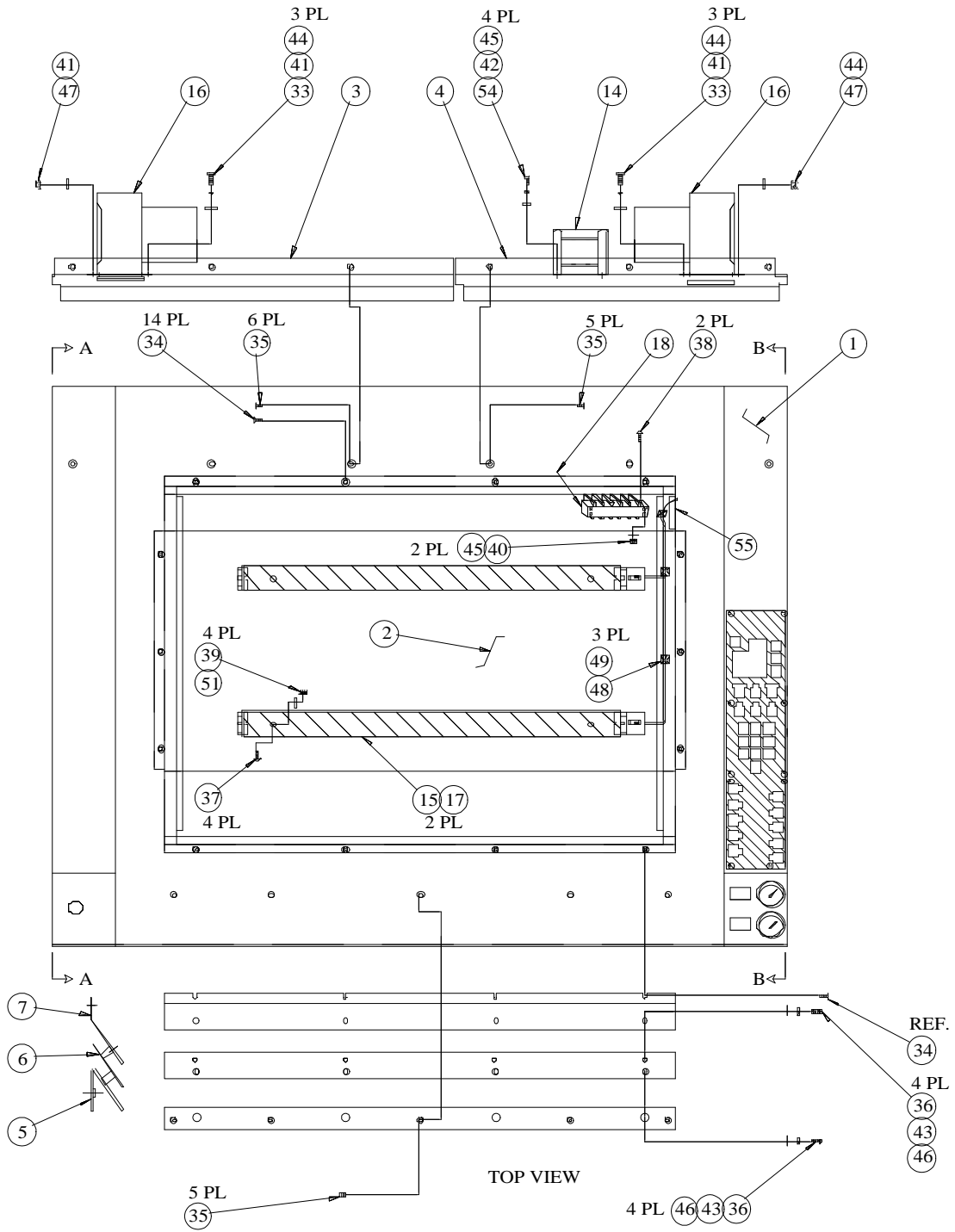

*Continued on next page*

## Nose Assembly Drawings (cont.)

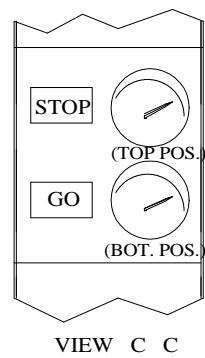
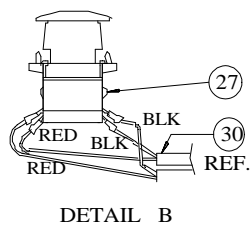
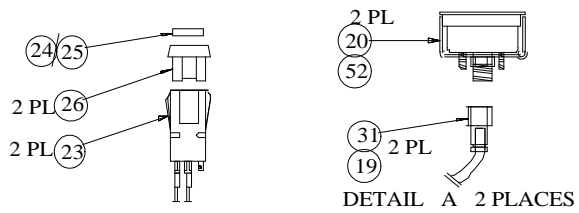
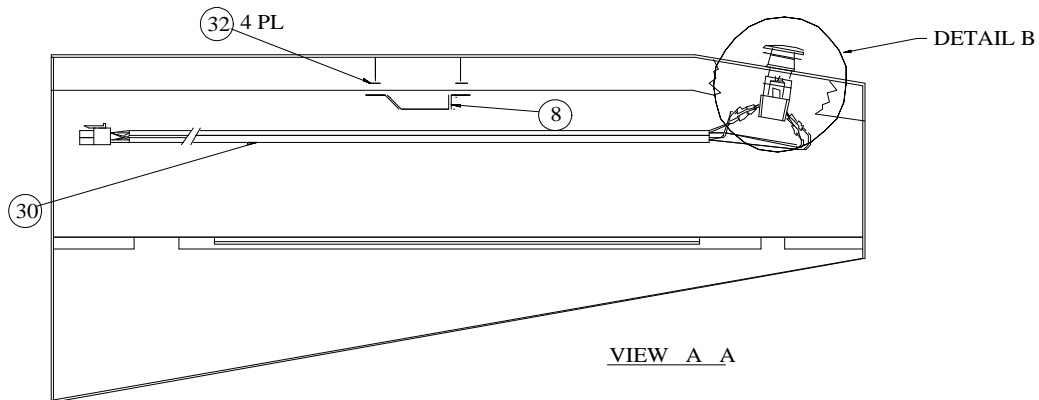
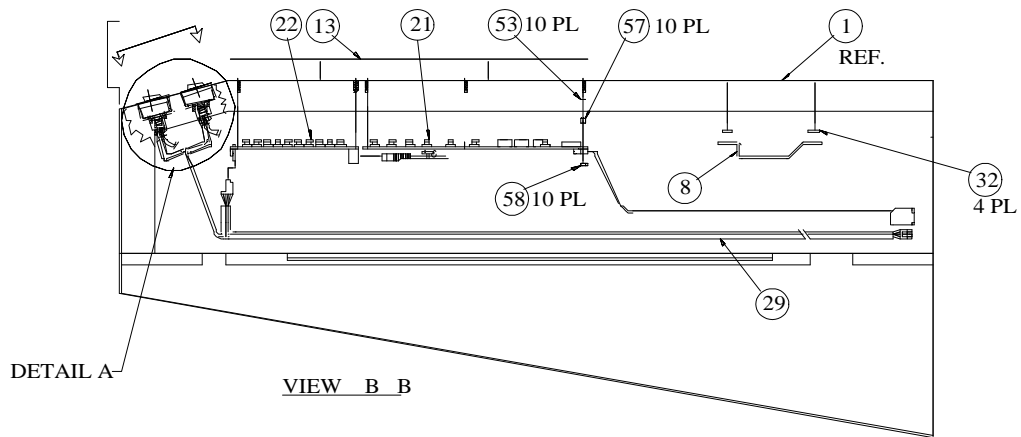

## 9. Exposure Trays

---

### Mylar® Replacement

- Close the Mylar® frame and open the six cam latches.
- Remove the inner Mylar® frame and position the pre-cut Mylar® sheet into the frame, make sure that the Mylar® is overlapping on all side.

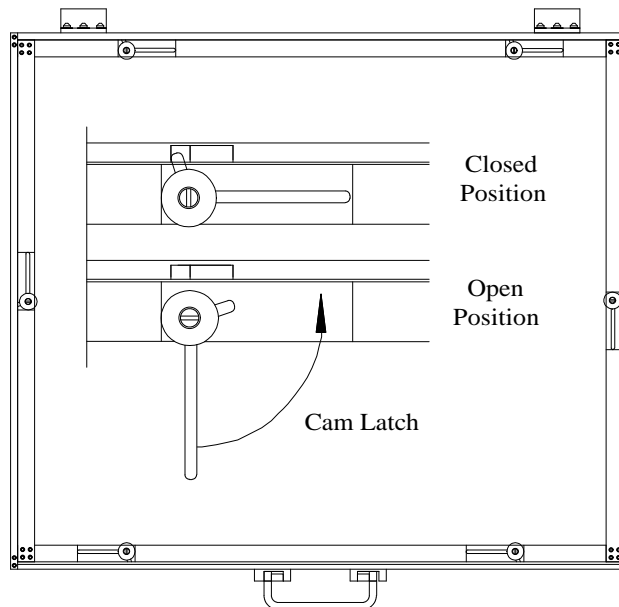

- Reinstall the inner Mylar® frame and ensure all cam latches are closed.
- Trim the excess Mylar® from between the inner and outer frames.

### If Mylar® Pulls Out of the Frame

- Make sure the Mylar® is not cut to small. The Mylar® must overlap on all sides so that it comes up between the inner and outer frames and then trimmed off once the inner frame has all the cam latches in the closed position.
- Make sure the inner and outer frames are not bent or damaged if they are replace them.

### Outer Frame Replacement

- Remove the inner frame.
- Open the frame then remove the safety clips from the gas shocks.
- While holding the frame up pull the gas shocks off of the mounting ball joints then lower the frame.
- Remove the 3 Allen screws from each of the two hinges in the back of the frame and lift the frame off.

---

**Note:** The frame MUST be aligned when it is reinstalled.

---

- Place the new frame flat on the tray, line up and insert the Allen head

screws through the hinge into the frame make sure the frame is  $\frac{1}{32}$ " to  $\frac{1}{16}$ " above the top of the hinge to avoid the possibility of damaging the glass, then tighten them down.

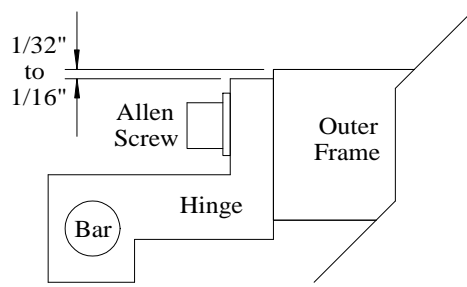

End View

- Loosen all the Allen head screws in the corners of the inner and outer frames shown in the diagram.
- Tighten the outer frame Allen head screws in the order shown in the diagram, 2 per corner.
- Tighten the inner frame Allen head screws in the order shown in the diagram, 4 per corner.

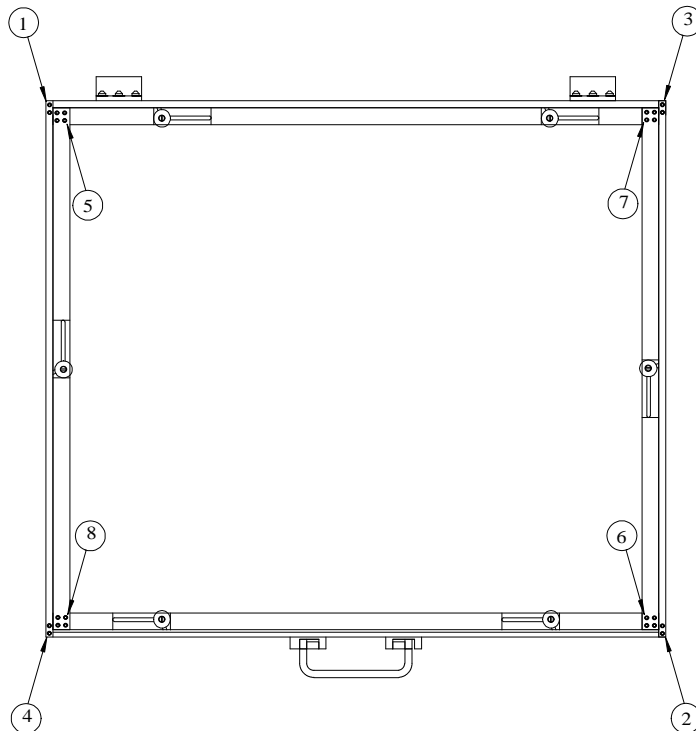

- Lift the frame and push the gas shocks back onto the ball joints.
- Reinstall the safety clips into the ends of the gas shocks.

# Tray Assembly Drawing

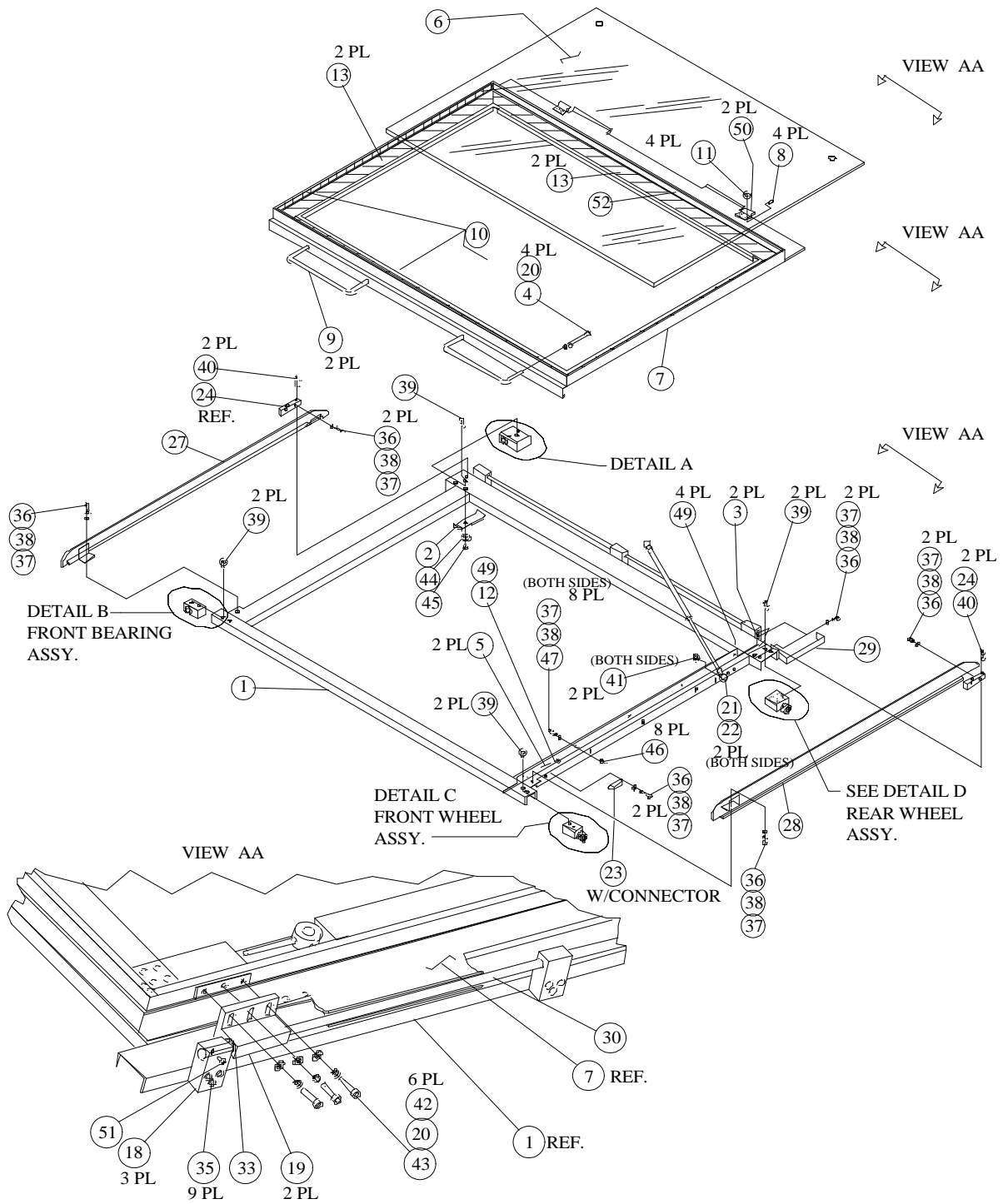

Continued on next page

## Tray Assembly Drawing (cont.)

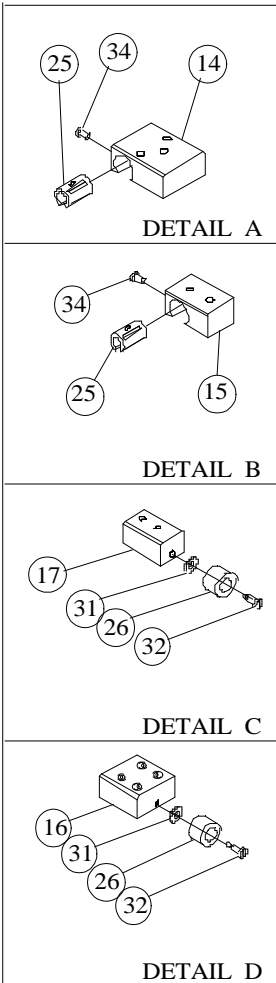

52	34"	SEAL "SOLID D"	44GKT07
51	1	NSI 8-32 X 1/4 PHIL PAN BLK	41B08PPS.25
50	4	TOP, HINGE, GLASS TRAY -AP30	11D2422A62
49	5	NSI CABLE TIE, UV, 4"	44TIE08
48	1	CABLE, MAGNETIC TRAY SWITCH	16D2970A00
47	8	NSI 6-32 X 1/2 PHIL PAN BLK	41B06PPS.50
46	8	NSI #6 KEP NUT ZINC	41-06NKP
45	1	1/4-20 X 3/8 BOTTON HEAD	41-F0SHB.37
44	1	1/4 SAE FLAT WASHER	41-40WFR
43	6	10-32 X 3/4 SHCS	41B12SHC.75
42	26	NSI #10 FLAT WASHER BLACK	41B10WFR
41	2	5/16-18 HEX NUTS BLK ZINC	41BF2NHX
40	4	NSI 1/4 - 20 X 1 SKT HD CAP	41BOSHC1.0
39	7	1/4-20 X 5/8 BTN HD SCREW	41BFOSHC.62
38	18	NSI #6 SPLIT LOCK WASHER	41-06WLS
37	18	NSI #6 FLAT WASHER, BLACK ZINC	41B06WFR
36	10	NSI 6-32 X 3/8 PHIL PAN BLK	41B06PPS.37
35	9	NSI 10-32 X5/8 SOC HD CAP BLK	41B12SHC.62
34	3	NSI 6-32 X 1/4 PHIL PAN BLK	41B06PPS.25
33	1	WASHER, .380 ID .625	41WFR03
32	2	NSI SOCKET SHOULDER BOLT-	41BF3SHC.50
31	2	WASHER, NYLON, 3/8 X3/4 X1/16	41HHS2679
30	1	PIVOT BAR, AP30/OV33	12D1727A99
29	1	BRACKET, VACUUM HOSE OV45	11D1696A02
28	1	GUIDE, LT. BLOCK UPPER AP30	11D1894B62
27	1	GUIDE, LT. BLOCK UPPER AP30	11D1894A62
26	2	WHEEL	12D1735A08
25	2	LINEAR BEARING 1/2" DIA.	43BLB12
24	2	LIGHT BLOCK GUIDE MOUNT	12D1737A62
23	1	SWITCH, MAGNETIC INTE.	55SW50-B
22	2	STUD, BALL FOR GAS SPRING	43SDB01
21	2	GAS SPRING 30 LBS	43SPR13-1
20	10	NSI #10 SPLIT LOCKWASHER	41-10WLS
19	2	HINGE, BLOCK	12D2418A71
18	3	END PIVOT BLOCK	12D1895A99
17	1	FRONT WHEEL BLOCK	12D1731A71
16	1	REAR WHEEL BLOCK	12D1733A00
15	1	FRONT BEARING BLOCK	12D1730A71
14	1	REAR BEARING BLOCK	12D1732A71
13	122"	TAPE, OV24 1/8" X 1" X 50	81TAP07
12	1	TIE WRAP ADHESIVE MOUNT BASE	44PAD03
11	4	NSI #10 KEP NUT ZINC	41-10NKP
10	92"	TAPE OV24 1/8" THK, 1/4 W.	81TAP06
9	2	HANDLE, 6". ALUM., BLK, 10X32T	44HDL03
8	4	NSI 10-32 C 1/2 PHIL FLAT MS	41B12PFO.50
7	1	GLASS FRAME - AP30	11D1726A02
6	1	GLASS, WATERWHITE AP30	18D1734B00
5	2	GIUDE, LIGHT BLOCK, LOWER	11D1657A62
4	4	10-32 X 2 PPMS ZINC	41-12PPMS2.0
3	2	NSI #6 X .125 ROUND SPACER	42HHS8500
2	1	RAMP, SWITCHES, AP30/OV33	11D2971A71
1	1	TRAY AP30/OV33	11D1892A02
ITEM	QTY	DESCRIPTION	PART NO.



# Inner Frame Assembly

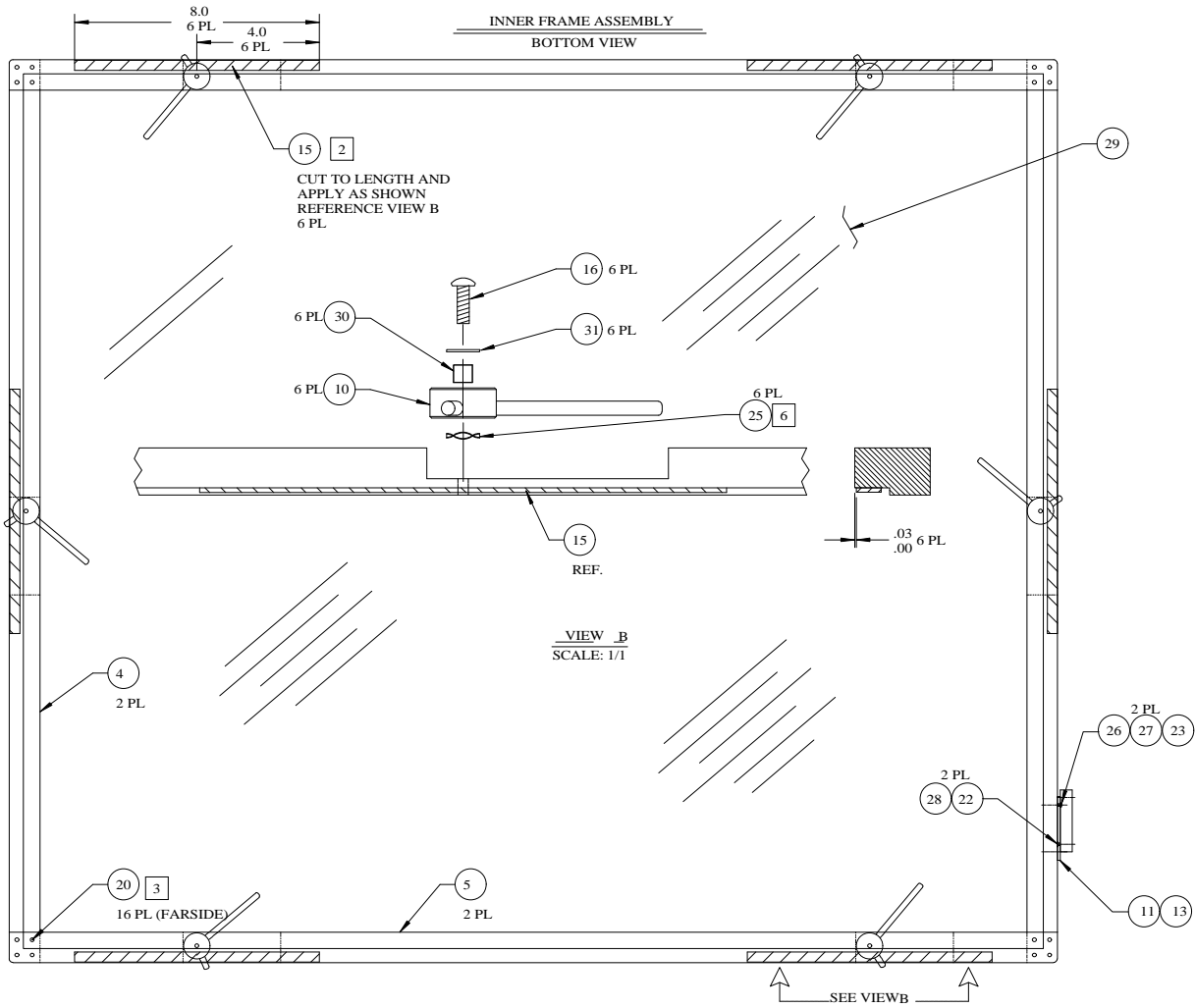

32	NSI #10 FLAT WASHER BLK	41B10WFR	3
31	NSI #8 FLAT WASHER, BLK	41B08WFR	6
30	NSI #8 X .250 SPACER	42HHS8521	6
29	PRE-PUNCHED MYLAR	91PPMC-04-H	1
28	NSI 6-32 FLEXLOCK NUT	41-06NLM	2
27	NSI #6 SPLIT LOCK WASHER	41-06WLS	2
26	NSI 6-32 X 3/8 PHIL BLK	41B06PPS.37	2
25	WAVE WASHER .25 ID	41-F0WSW	6
24	NSI 10-32 X .50 PHIL PAN	41B12PPS.50	2
23	NSI #6 FLAT WASHER BLK	41B06WFR	2
22	NSI 6-32 X 3/8 FLT BLK	41B06PFO.37	2
21	SHCS, 10-32 X 3/4	41B12SHC.75	6
20	SHCS, 8-32 X 3/8	41B08SHC.37	24
19	BALL STUD, SHRT.	12D2476A00	2
18	KEP NUT, #10-32	41B12NKP	2
17	SCREW, SHLDR $\phi$ .187 X 1.25	41-0BSBL1.25	2

16	NSI #8X1/2 PPMS BLACK	41B08PPS.50	6
15	GASKET, .33W X .06THK.	44GKT11	-
14	SPRING, 7/16 X 9/16 COMP.	43SPR12	2
13	SWITCH, MAGNETIC INTE.	55SW50-B	1
12	HANDLE, 6 INCH	44HDL03	1
11	MOUNT, MAGNETIC SWITCH	11D2971A71	2
10	CAM LATCH	12D2379A76	6
9	CATCH	11D2392A62	1
8	LATCH	12D2391A76	2
7	MOUNT, HANDLE	12D2390A76	2
6	BASE, HANDLE/LATCH	12D2389A76	2
5	FRAME, MYLAR, INNER-F/R	12D2382B76	2
4	FRAME, MYLAR, INNER-SIDES	12D2382A76	2
3	FRAME, MYLAR, OUTER-SIDES	12D2381A76	2
2	FRAME, MYLAR, OUTER-FRONT	12D2380B76	1
1	FRAME, MYLAR, OUTER-REAR	12D2380A76	1
ITEM NO.	DESCRIPTION	OLEC P/N	QTY.

PARTS LIST



## Gas Strut Removal

Each frame assembly has two gas struts to support the top coversheet frame when it is opened.

- Open the frame with the strut to be replaced.
- Remove the retainer from both ends of the strut.
- Pull the strut from the retaining ball mounts.
- Install the new strut in the reverse order.

## Replacing the linear bearings

There are two linear bearings on the left-hand side of each exposure frame, one in the front and one in the rear. They move along the track when the frames move in and out of the unit. Check the linear bearings if frame transport becomes noisy.

---

**Note:** At this point locate items 14, 15, 24, 25, 27, 34, 36, 37, 38 & 39 in the Tray Assembly Drawings.

---

### To remove the front bearings:

- Loosen the nose and slide it forward about 2" (See section 9.1 Removing the Nose.).
- Disconnect the mox plug at the tray motor and move the frame to be worked on to the front.
- Remove the Phillips screw attaching the front of the light block guide to the frame (upper frame only).
- Remove both linear bearing retainer block screws using a  $\frac{5}{32}$ " Allen wrench.
- Lift the frame and slide the linear bearing and linear bearing retainer block forward and off.
- Remove the Phillips screw attaching the linear bearing to the linear bearing retainer block and replace it.
- Install in reverse order.

### To replace the rear bearings:

Disconnect the mox plug at the tray motor and move the frame to be worked on to the rear.

- Remove light block guide mount from the frame using a  $\frac{5}{32}$ " Allen wrench.
- Remove the remaining linear bearing retainer block screw using a  $\frac{5}{32}$ " Allen wrench.
- Lift the frame and slide the linear bearing and linear bearing retainer block back and off.
- Remove the Phillips screw attaching the linear bearing to the linear bearing retainer block and replace it.
- Install in reverse order.

## **Frame Glass Replacement**

---

**Note:** Wear leather gloves and safety glasses when performing this procedure.

---

- Open the frame to be changed.
- Remove the two glass retaining screws on the front edge of the glass frame.
- Push up on the glass from under the frame. Hold it up about 12 inches (305 mm) off of the frame.
- Disconnect both vacuum hoses and lift out the glass.
- Install new glass in the reverse order.

## **Gas Strut Replacement**

Each frame assembly has two gas struts to support the top coversheet frame when it is opened.

- Open the frame with the strut to be replaced.
- Remove the retainer from both ends of the strut.
- Pull the strut from the retaining ball mounts.
- Install the new strut in the reverse order.

# 10. Center/Drive Assembly

## Center/Drive Assembly Diagram

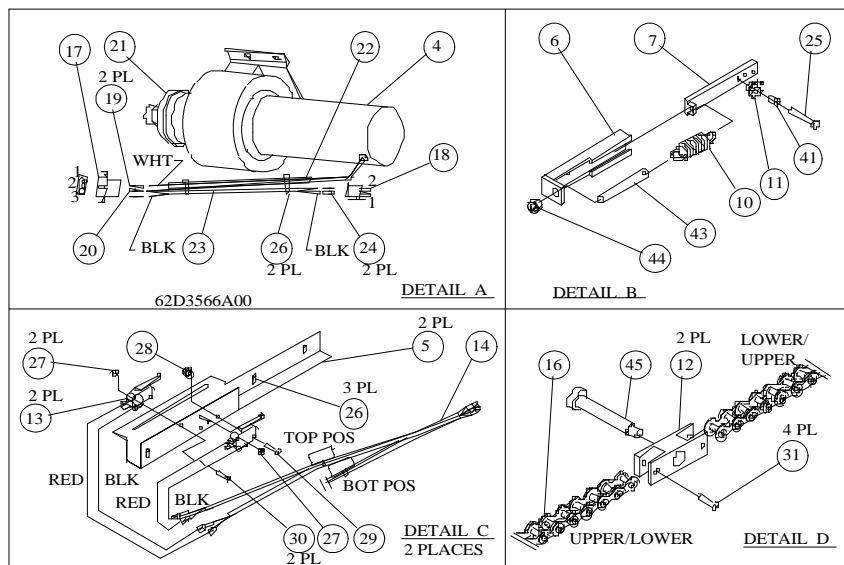
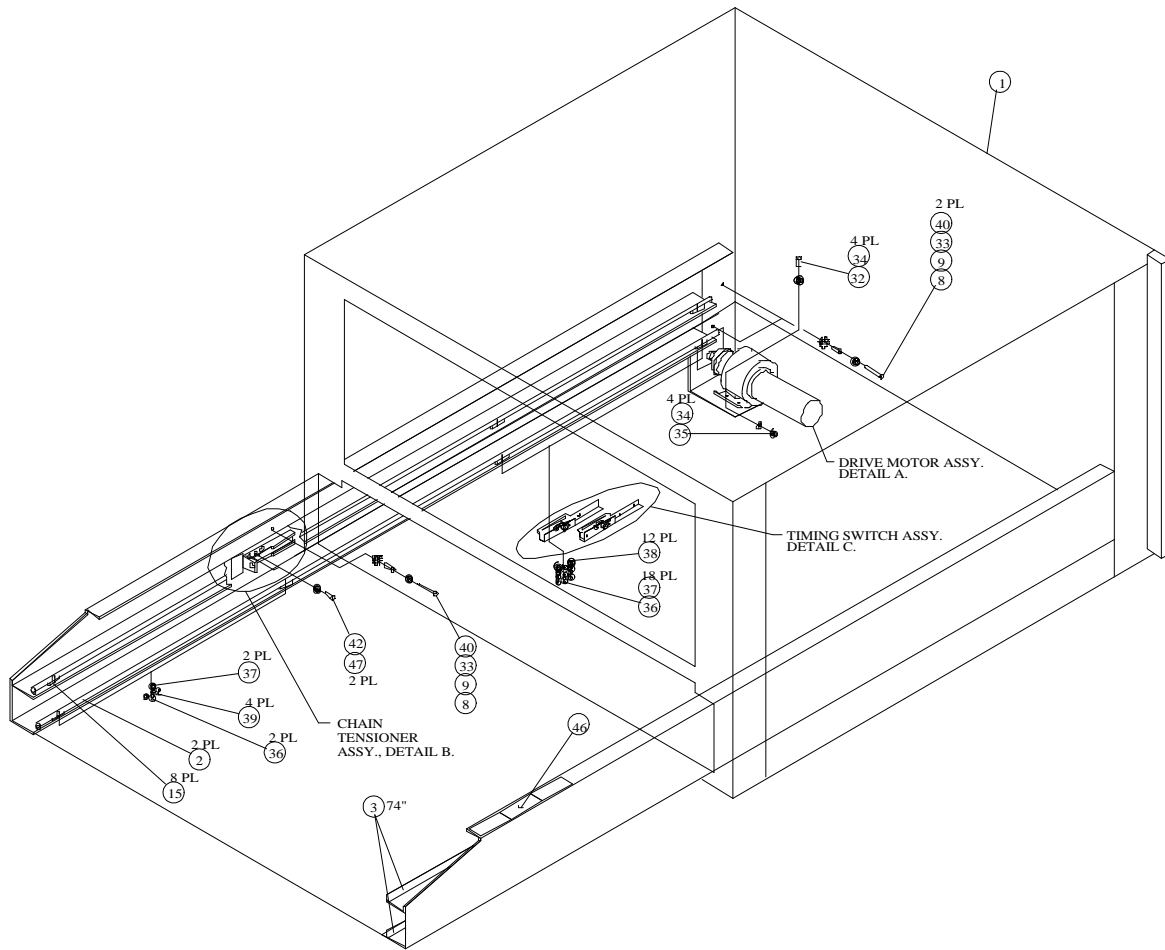



Continued on next page





## Center/Drive Assembly Diagram (cont.)

47	2	5/16 SPLIT LOCK WASHER	41F2WLS
46	1	INSUALTION PAD AL13/14	15D725
45	2	NSI 3/8 X 3/4 SOC. SHLD.	41BF2SHF.62
44	1	3/8-6 NYLON LOCK NUT, OV45	41-F3NLN
43	1	THREADED ROD	12D1751A00
42	2	5/16 - 18 X 3/4 HEX BOLT BLK.	41BF2BHX.75
41	1	TENSIONER BUSHING	12D1755A00
40	3	NSI 1/4-20 X 1 3/4 HEX BOLT BK	41B40BHX1.75
39	4	NSI 8-32 5/8 FLAT HEAD 82	41B08PF2.62
38	12	NSI #10 FLAT WASHER BLACK	41B10WFR
37	18	NS #10 LOCK WASHER SPLIT	41-10WLS
36	20	NSI 8-32 X 1/2 SOC. HD CAP SCR	41B08SHC.50
35	4	NSI 1/4-20 LOCKNUT NYLON INS.	41B40NLN
34	8	NSI 1/4 SAE FLAT WASHER	41-FOWLS
33	3	WASHER, SPLIT LOC 1/4"	41 40WFR
32	4	1/4-20 X 3/4 HEX HEAD BOLT	41-FOBHX.75
31	4	NSI 6-32 X 3/4 PPMS ZINC	41-06PPS.75
30	4	4/40 X 5/8 PHIL FLAT MS	41-04PFO.62
29	2	NSI 6-32 X 5/8 PPMS ZINC	41-06PPS.62
28	2	NSI 4/40 KEP NUT	41-04NKP
27	6	NSI 4/40 FLEXLOCK METAL	41-04NLM
26	8	NSI CABLE TIE, UV, 4"	44TIE08
25	1	NSI 1/4-20 X 1.25 HEX BOLT BLK	41B40BHX1.25
24	2	TERMINAL, FEMALE MINIFIT	51TML05
23	10"	WIRE, 22 GAUGE, BLK 2 CON.	54M22BLK2
22	8"	1/4' HEAT SHRINK TUBBING	49DCT05
21	1	OVERTORGUE SAFETY DEVICE	43OSD01
20	1	TERMINAL FEMALE 14-20 AWG.	51TML04
19	2	TERMINAL FEMALE 18-22 AWG.	51TML02
18	1	RECEPTACLE, 2 PIN, MINIFIT	52RCP28
17	1	PLUG, 3 PIN MOLEX, .093 PIN	52CTP08
16	1	CHAIN, #35 RLR- 10 FT	43CHA05
15	8	BLOCK, MOUNT AC-TRACK	12D1635A00
14	1	HARNESS, MOTOR- POS SWT	16D2319A00
13	4	SWITCH, TIMING-ROLLER	55SW02
12	2	CHAIN YOKE	12D1757A62
11	1	TENSIONER SPROCKET	12D1996A00
10	1	SPRING, CHAIN TENSIONER	43SPR14
9	3	IDLER BUSHING	12D1754A00
8	3	IDLER SPROCKET	12D1753A00
7	1	SLIDER	12D1752A62
6	1	SLIDE	12D1750A62
5	2	SWITCH MOUNT, AP30/OV33	11D2111A62
4	1	MOTOR, DRIVE, 1/8 HP, 90VDC	31MOT14
3	148"	TAPE GLIDE (BLACK UHMW)	81TAP16
2	2	ACCUTRACK	12D1634A00
1	1	CABINET, WELDMENT AP30	63D3326A08
ITEM	QTY	DESCRIPTION	PART NO.

## Frame Transport System

The printer has two aluminum exposure frame assemblies. Vacuum for frame evacuation is drawn through two ports in the glass; one at each of the rear corners. The top coversheet frame is hinged in the back, with a gas strut on each side that hold the cover-sheet frame open.

The exposure frame transport system is powered by a  $\frac{1}{8}$ -hp PMDC gear motor. It is controlled and operated by the computer system, through the nose section  and  switches.

Pressing the  switch once will start a vacuum cycle. The second time  is pressed, the frames will move into position and an exposure will start. The frames can be operated through a blank frame cycle by holding down the  switch before pressing the  switch.

The frames move at two speeds; a fast speed initially, then to a slow speed near the end of their travel. This prevents a noisy, hard-stop condition and possible machine damage. For added safety, the drive motor has a slip clutch to prevent machine damage. A system switch inside the cabinet stops frame movement when it is actuated by the frame moving into the exposure position. If the system switch fails, the frame contacts a second switch that turns off power to the frame drive motor.

## Frame Drive Motor Replacement

The drive motor is in the left rear corner of the cabinet. It is a  $\frac{1}{8}$ -hp PMDC (Permanent Magnet Direct Current) design, with a slip clutch on the output shaft. The clutch is intended to prevent frame damage in the event of a jam or if an object blocks frame movement. Refer to “Frame Drive Clutch Adjustment” for procedures.

---

**Note:** Remove your watch when working on the drive motor. The drive motor magnet could damage watches or similar devices.

---

- Remove the left side cabinet door.
- Disconnect the motor connector from the control box.
- Position both frames to approximately a mid-point state.
- Disconnect the two wire connectors at the motor end of the drive motor.
- Remove the four  $\frac{1}{4}$ -20 x  $\frac{3}{8}$ " bolts that attach the motor to its mounting plate and lift out the motor.
- Install the new motor in the reverse order.

## Frame Drive Clutch Adjustment

A personnel safety hazard may exist, or machine damage may occur if the slip clutch on the exposure frame drive motor is set too tight. If the clutch is set too loose, the frame drive will be too slow and a transport error may occur. Use the following procedure to set the clutch at the minimum setting for operation.

- Open the left side sliding door on the printer and locate the drive motor at the left rear corner of the cabinet.
- Loosen the two set screws which lock the hex nut to the motor shaft.
- Adjust the hex nut until the minimum setting is found that provides frame movement with no slippage.
- Retighten the set screws in the hex nut.
- Close the sliding door.

### Frame Speed Adjustment

---

**Note:** Frame speed is set at the factory and normally does not require adjustment.

---

**Note:** An adjustment of the frame speed must be preformed whenever the Control Box PCB, part #64CT464, or the Motor Speed Control Board, part #31MSC02 is replaced. This adjustment is critical, failure to do so can damage the board and/or hardware.

---

- Locate the 'FAST' and 'SLOW' potentiometers in the upper lefthand corner of the Control Box. The frame speed adjustments will be made from these pots.

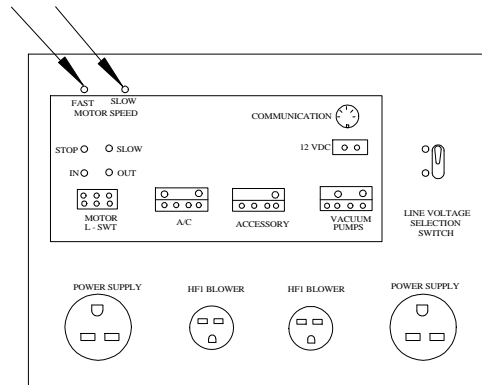

### Activate the Diagnostics Mode through the keypad;

Press the **1**, **2**, **3** then **4** keys, the center display will read **SEL**.

Press the **6** key: this will activate the diagnostic mode.

Press the **9** key: this will reset the Vacuum window to **0000**.

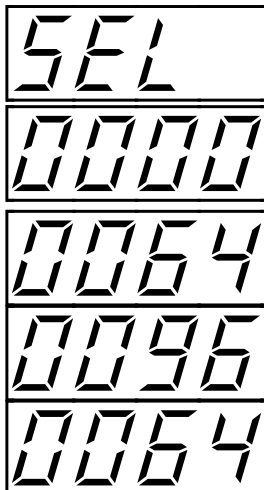

Press the **7** key to set motor drive: the Vacuum window should read **0064**.

Press the **6** key: upper tray should move in, the Vacuum window should read **0096**.

Press the **6** key: lower tray should move in, the Vacuum window should read **0064**.



Press the **6** key again: upper tray should move in, the Vacuum window should read **0096**.

- Set volt meter for VDC and measure across pins 5 & 6 on motor speed connector. Adjust the 'SLOW' pot on the control box to read 25 to 32 VDC. Notice that the frame moves slower than normal. The total travel time of the frame should be 12 seconds.

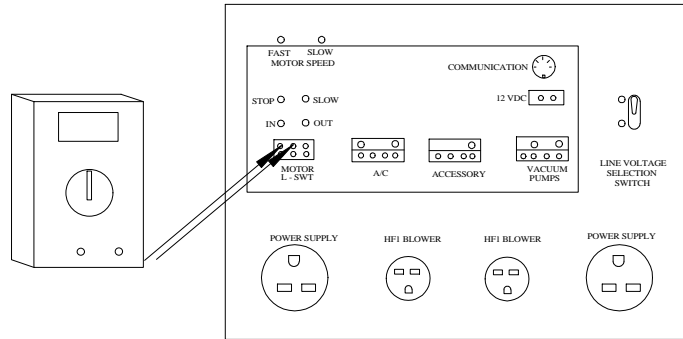

- Exit the diagnostic mode by pressing the 9 key then the 0 key.

### Adjust the 'FAST' pot on the control box.

- Depress and hold the 'STOP' key then press the 'GO' key and then release both keys to start a blank frame cycle, no vacuum or exposure.
- Measure across pins 5 & 6 on motor speed connector. Adjust the 'FAST' pot on the control box to read between 70 and 84 VDC. The frame should travel at high speed for about 4.5 seconds, then shift to a slower speed and stop about 0.750" to 1" from the end of the tray rod.

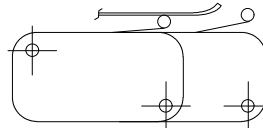

**CAUTION** Verify the adjustment by noting the position of the frame when it is inside the Unit. Check the frame position switches for each frame. When adjusted properly, the frame will come to a stop depressing the first switch, but not the second. If the second switch is depressed, check slow speed adjustment.

# Light Block Assembly

## Light Block Assembly Drawing

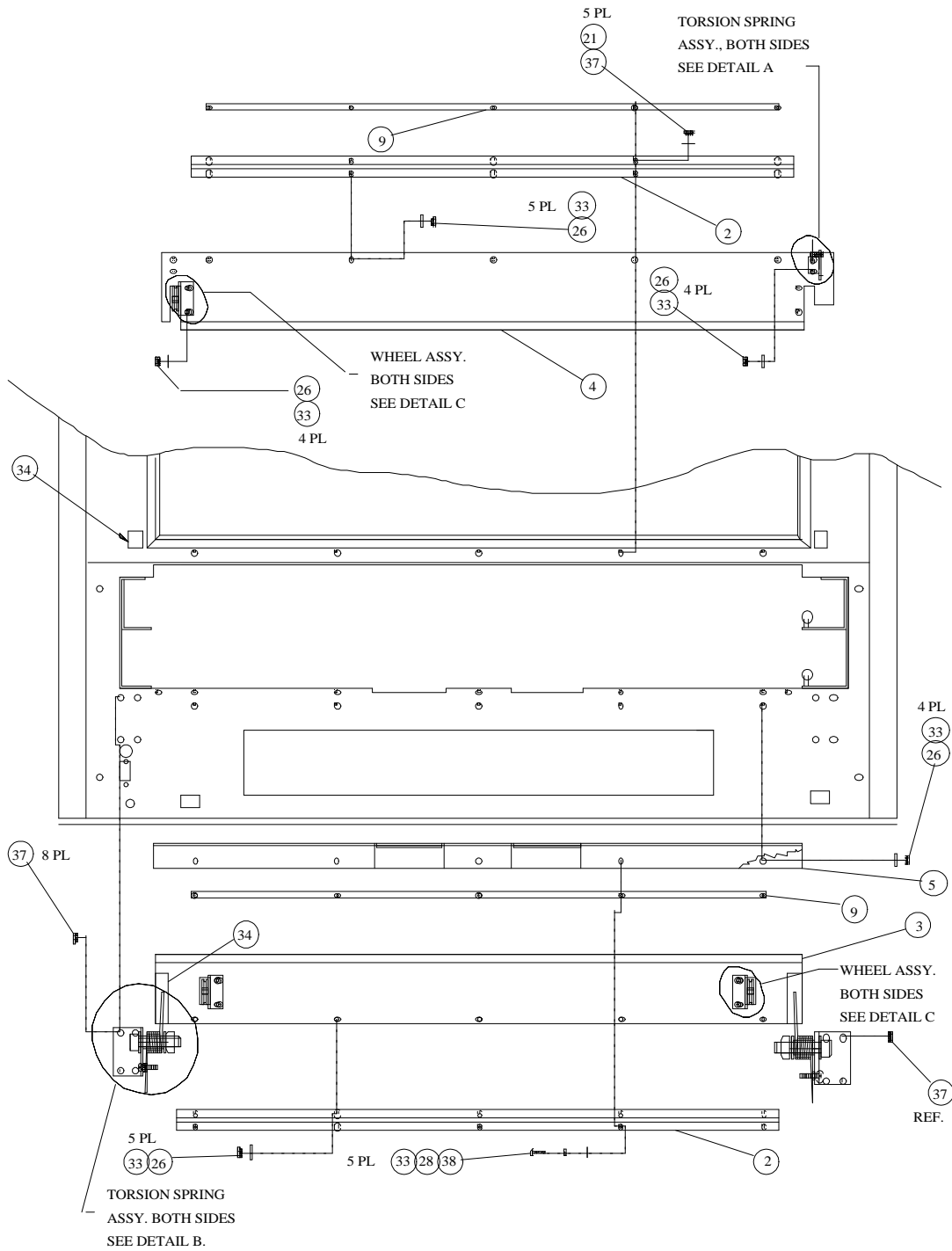

Continued on next page



## Light Block Assembly Drawing (cont.)

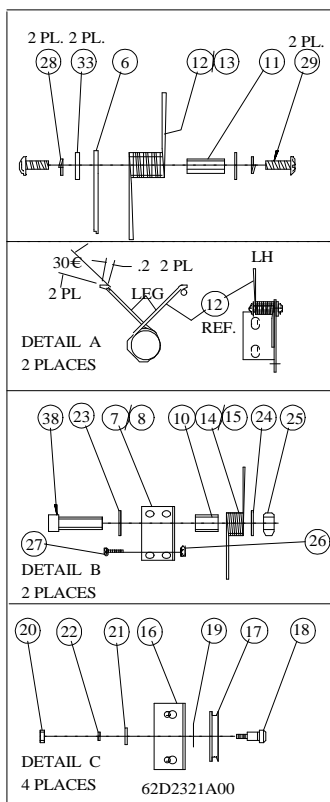

40	1	FRONT CABINET, AP30	11D2492A06
39	8	NSI #10 FLAT WASHER SAE	41-10WFR
38	19	NSI 6-32 X 1/2 PPMS ZINC	41B06PPS.50
37	8	NSI 10-32 KEP NUT ZINC	41-12NKP
36	2	NSI 1/2-13 X 2.O OSHCS-BLK	41BF5SHC2.0
35	5	NSI 8-32 KEP NUT ZINC	41-08NKP
34	8"	TAPE, GLIDE (BLACK UHMW)	81TAP16
33	41	NSI #6 FLAT WASHER BLACK	41B06WFR
32	1	FRONT, CABINET- AP30	11D2492A06
31	1	BEZEL, FRONT PANEL-NEW	11D3173A06
30	14	NSI 10-32 X 1/2 PPMS, ZINC	41-12PPS.50
29	4	NSI 6-32 X 3/8 PHIL PAN MS ZINC	41B06PPS.37
28	23	NSI #6 LOCK WASHER, SPLIT	41-06WLS
27	2	NSI 6-32 X 3/4 PPMS ZINC	41-06PPS.75
26	24	NSI 6-32 KEP NUT ZINC	41-06NKP
25	2	#1/2 - 13 HEX NUT	41-F5NHX
24	2	1/2" THICK FLAT WASHER	41-F5WFT
23	2	NSI 1/2 FLAT WASHER	41-F5WFR
22	4	NSI #10 LOCKWASHER SPLIT	41-10WLS
21	9	NSI #8 FLAT WASHER, BLACK	41B08WFR
20	4	NSI 10 X 24 HEX NUT ZINC	41-14NHX
19	4	NSI 1/4 SAE FLAT WASHER	41-40WFR
18	4	NSI SHOULDER SCREW .37	41BF1SHC.37
17	4	NYLON IDLER PULLY	49PUL01
16	4	BRACKET, WHEEL MOUNT	11D1659A99
15	1	SPRING, TORSION LH (LOW)	43SPR22
14	1	SPRING, TORSION RH (LOW)	43SPR21
13	1	SPRING, TORSION RH	43SPR18
12	1	SPRING, TORSION LH	43SPR17
11	2	#6 BRASS RND. THD. SPACER	42HHS8779
10	2	MANDREL, SPRING, LOW LT. BLOK	12D2053A62
9	2	SPACER, HINGE	11D2202A02
8	1	MOUNT, SPRING, LOW LT. BLOK-LF	11D2051B62
7	1	MOUNT, SPRING, LOW LT. BLOK-RT	11D2051A62
6	2	MOUNT, SPRING,LOW LT. BLK AP30	11D1660A99
5	1	BRACKET, HINGE OFFSET - AP30	11D1662A17
4	1	LIGHT BLOCK TOP	11D1632A17
3	1	LIGHT BLOCK LOWER AP30	11D1631A17
2	2	HINGE 6 FT. LONG	43HNG05
1	1	CABINET, WELDMENT AP30	63D3326A08
ITEM	QTY	DESCRIPTION	PART NO.

### Replacing Lower Light Block Springs

- Move upper exposure frame into the cabinet.
- Disconnect main power.
- Open left and right doors.
- Remove the left mounting bracket first.

*Continued on next page.*

- Use the new mounting bracket.
- Insert two 8-32 x 0.62" screws and secure to mounting bracket with two 8-32 kep nuts.
- Use the  $\frac{1}{2}$ -13 x 2.0" shoulder screw and large  $\frac{1}{2}$ " washer and insert to the hole in the mounting bracket. Place the mandrel over the shoulder screw.
- Place left spring over mandrel.
- Secure washer and nut over shoulder screw.

# 11. Air Conditioning System

---

## Compressor

The air conditioning compressor requires no routine maintenance. It is hermetically sealed, properly lubricated at the factory, and should provide years of satisfactory operating service.

Should the refrigerant charge be lost, recharging ports (access fittings) on the suction and discharge sides of the compressor are provided for recharging and/or checking suction and discharge pressures.



**WARNING** ⚠ The access fitting covers should never be loosened, or removed, except by trained refrigeration service personnel.

## Inlet Filter

Proper maintenance of the inlet filter will assure proper operation of the air conditioner. Delaying or ignoring filter maintenance will reduce the maximum ambient temperature under which the unit will operate.

The compressor operating temperature will increase above normal if the inlet filter is dirty or clogged or if the condenser coil is plugged. This is caused by a reduction in cooling air flow across the surface of the compressor and condenser coil. The air conditioner compressor will shut down if the thermal overload cutout switch located on the compressor housing is actuated.

When the compressor temperature has dropped to within the thermal overload switch's cutin setting, the compressor will restart automatically. However, shut downs will reoccur until the inlet filter has been cleaned or replaced.

It is recommended that power to the air conditioner be manually interrupted when abnormally high compressor operating temperatures cause automatic shutdown of the unit.



**CAUTION** ⚠ Continued operation under the above conditions will damage the compressor and shorten its life. The air conditioner features an easily removable inlet filter to facilitate necessary cleaning. There should be no reason to neglect this necessary maintenance.

## Intake Filter Removal And Installation

**Note:** Orient the filter according to AIR FLOW arrow on filter frame.

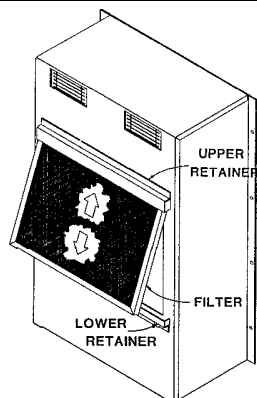

- The filter is located on the back of the exposure unit. Lift the filter high enough for the bottom to clear the lower filter retainer.
- Pull the bottom of the filter toward you, pressing downward until the top of the filter clears the upper filter retainer. Remove CAREFULLY if the air conditioning unit is operating, to assure that no dirt from the filter enters the air intake opening.
- If the filter is to be cleaned, see “Intake Filter Cleaning.”
- Install the cleaned or new filter by sliding the top of the filter into upper retainer. Push the filter against it, and slide the filter bottom into lower retainer.



### Intake Filter Cleaning

**CAUTION** Do not run the air conditioner for extended periods of time with the inlet filter removed. A buildup of dirt can plug the fins of the condenser coil, which will give the same reaction as a plugged filter. The condenser coil is not visible through the filter opening, therefore we recommend that you protect it with a clean filter!

Aluminum washable air filters are designed to provide excellent filtering efficiency with high dust holding capacity, and minimum air flow resistance. Because they are constructed entirely of aluminum, they are light weight and easy to service.

To achieve maximum performance from your air handling equipment, air filters should be cleaned on a regular basis.

- Flush the filter with warm water from the exhaust side to the intake side.

**Note:** The air flow arrow on the frame.

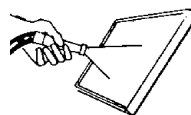

**Note:** Never use caustic solutions to clean the aluminum filter.

- After flushing, allow filter to drain. Placing it with a corner down will assure complete drainage.
- Amounts of airborne dust and dirt particles are different in every location. When a fine layer of dust or lint is visible on the surface of the filter, remove and clean the filter.

### **Condenser & Evaporator Blowers**

- The blower motors require no maintenance. All bearings, shafts, etc., are lubricated during manufacturing for the life of the motor.
- Operation of the air conditioners in areas containing airborne caustics or chemicals can rapidly deteriorate filters, condenser coils, blowers, and motors.
- If the condenser blower motor (top blower) should fail, it is not necessary to remove the air conditioner from the cabinet or enclosure to replace the blower. The condenser blower is mounted on its own and is easily accessible by removing the front access panel.

### **Refrigerant Loss**

- Your air conditioner was thoroughly tested to ensure against refrigeration leaks. Shipping damage or microscopic leaks not found with sensitive electronic refrigerant leak detection equipment during manufacture may require repair and recharging of the system. This work should be performed by qualified professionals only, generally available through an air conditioning repair or service company in your local area.
- Refer to the data on the air conditioner nameplate which specifies the type of refrigerant and the charge size in ounces. Before recharging, make sure there are no leaks and that the system has been properly evacuated by deep vacuum.



# 12. Diagrams

## Control Box Front View

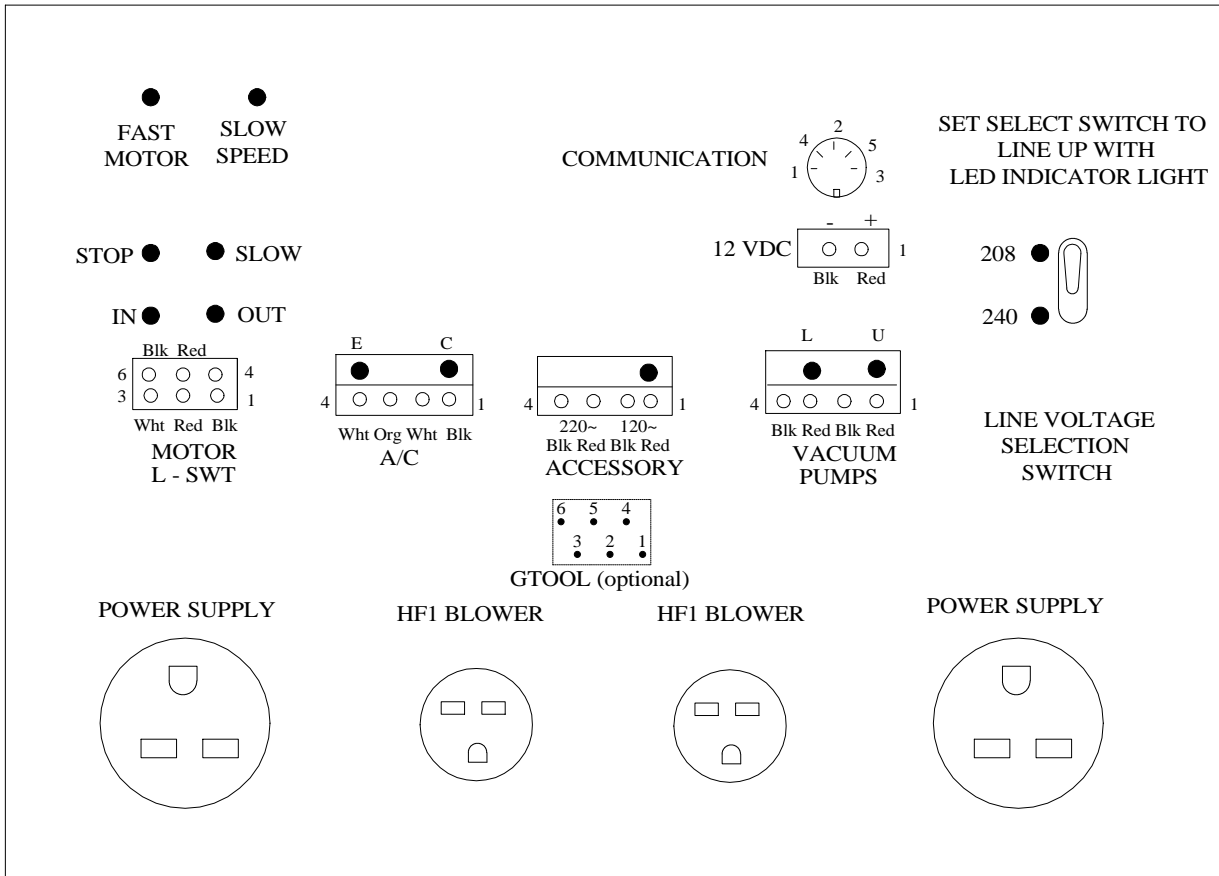







### Control Box Wiring Diagram (Standard with 8kW)

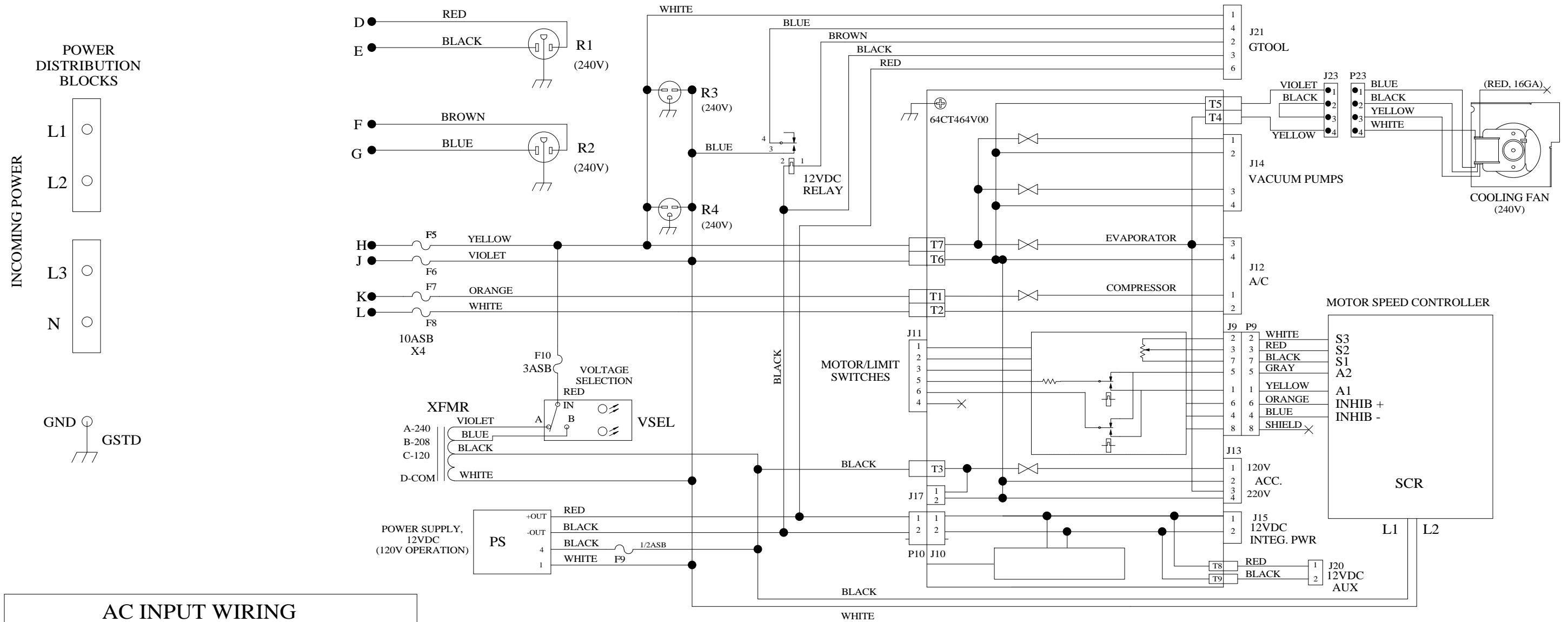

AC INPUT WIRING			
TERM.	380 V ~ (W/ 240V P/S) 3-PHASE (WYE)	208/240 V ~ 3-PHASE (DELTA)	208/240 V ~ SINGLE PHASE
L1	E	F, J, L	D, F, H, K
L2	G	G, D	E, G, J, L
L3	H, K	E, H, K	NOT USED
N	D, F, J, L	NOT USED	NOT USED

### Control Box Wiring Diagram (480V all)

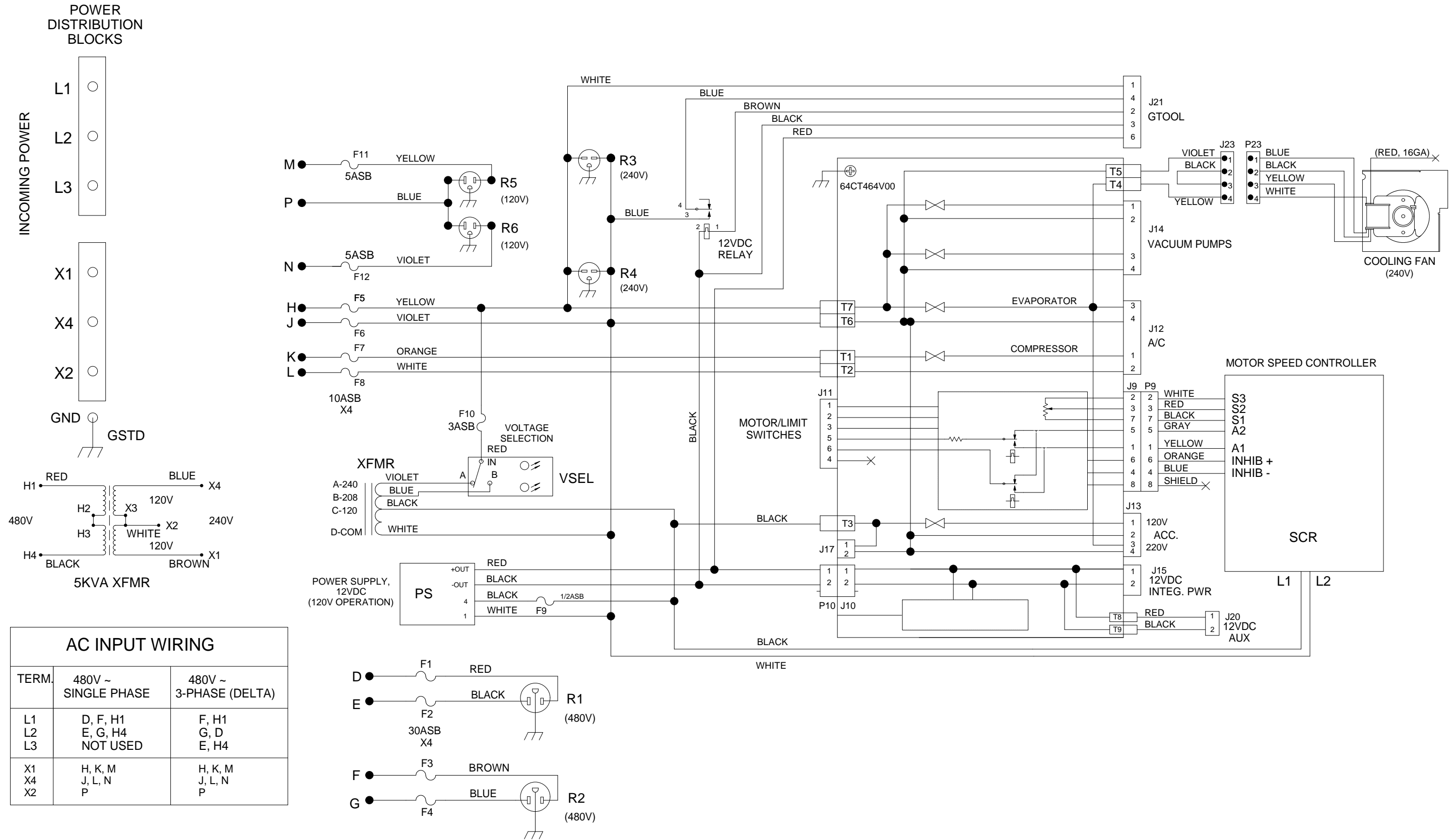

AC INPUT WIRING		
TERM.	480V ~ SINGLE PHASE	480V ~ 3-PHASE (DELTA)
L1	D, F, H1	F, H1
L2	E, G, H4	G, D
L3	NOT USED	E, H4
X1	H, K, M	H, K, M
X4	J, L, N	J, L, N
X2	P	P

### Control Box Wiring Diagram (CE all)

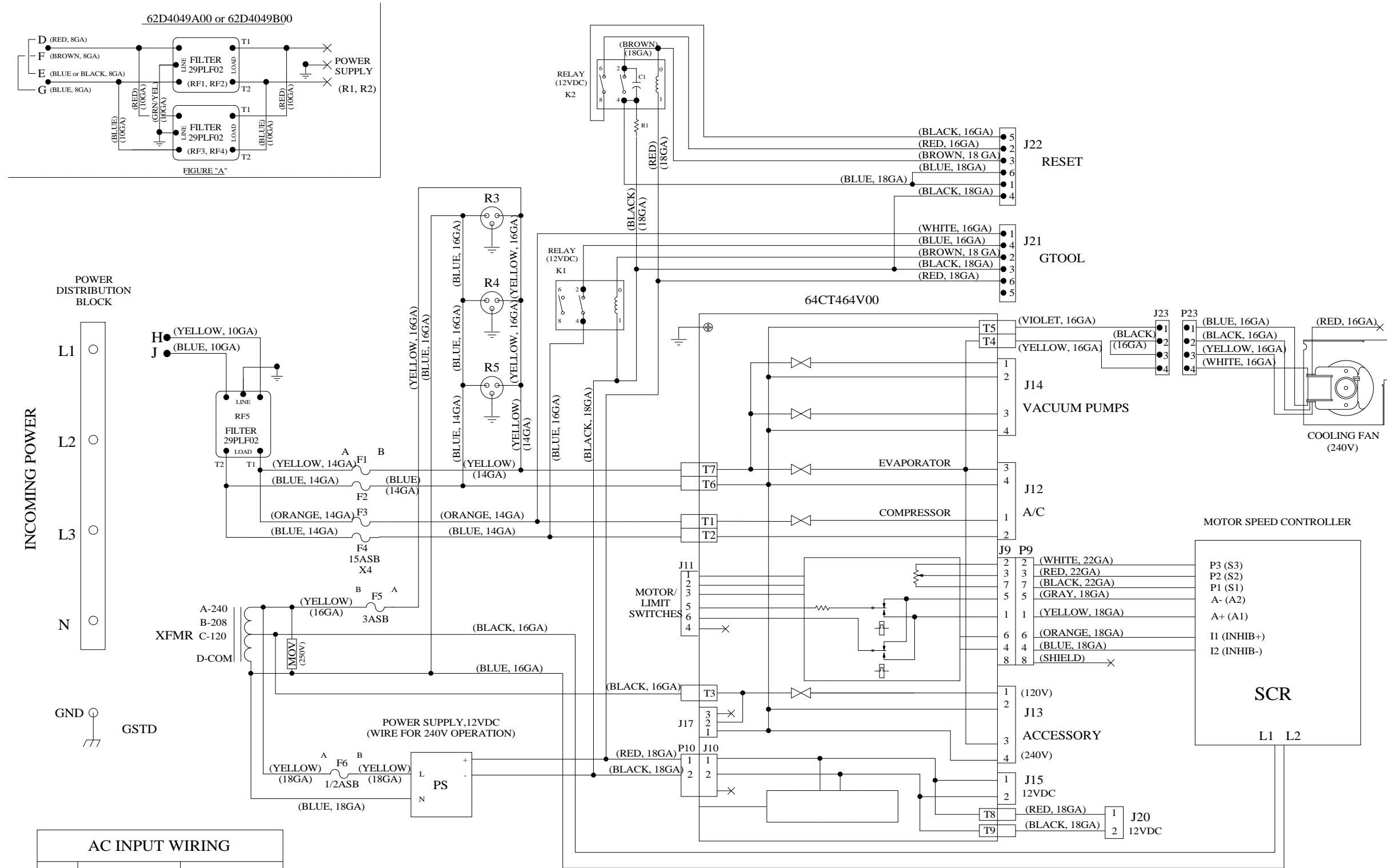

AC INPUT WIRING		
P/S	62D4049A00	62D4049B00
TERM.	380-415V ~ (W/ 240V P/S) 3-PHASE (WYE)	208-240V ~ (W/ 240V P/S) 3-PHASE (DELTA)
L1	D	D,H
L2	F	E,F
L3	H	G,J
N	J,E,G	NOT USED

**Unit Cabling Diagram (old nose)**

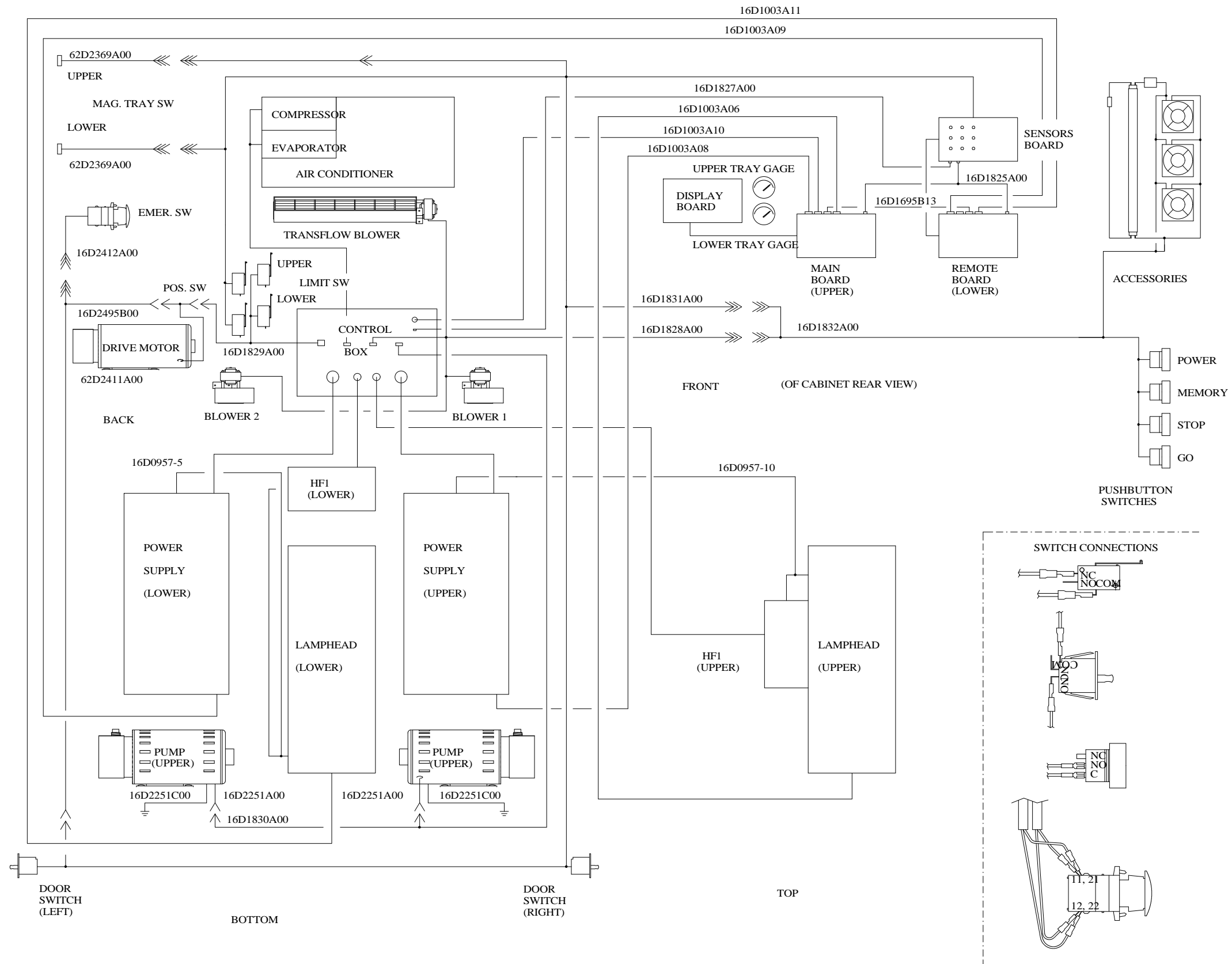

# Unit Cabling Diagram (new nose)

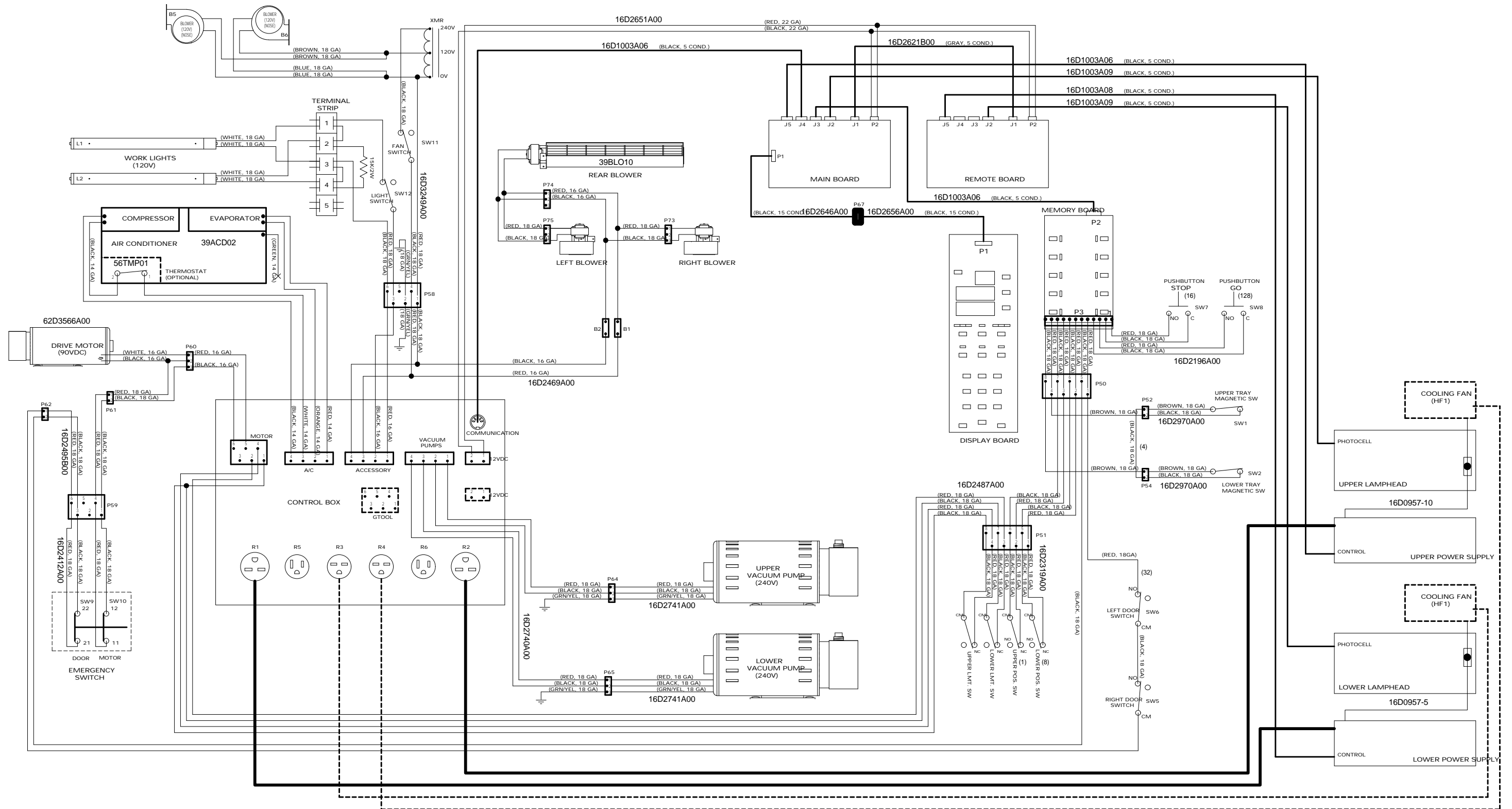

# Unit Wiring and Tubing Diagram

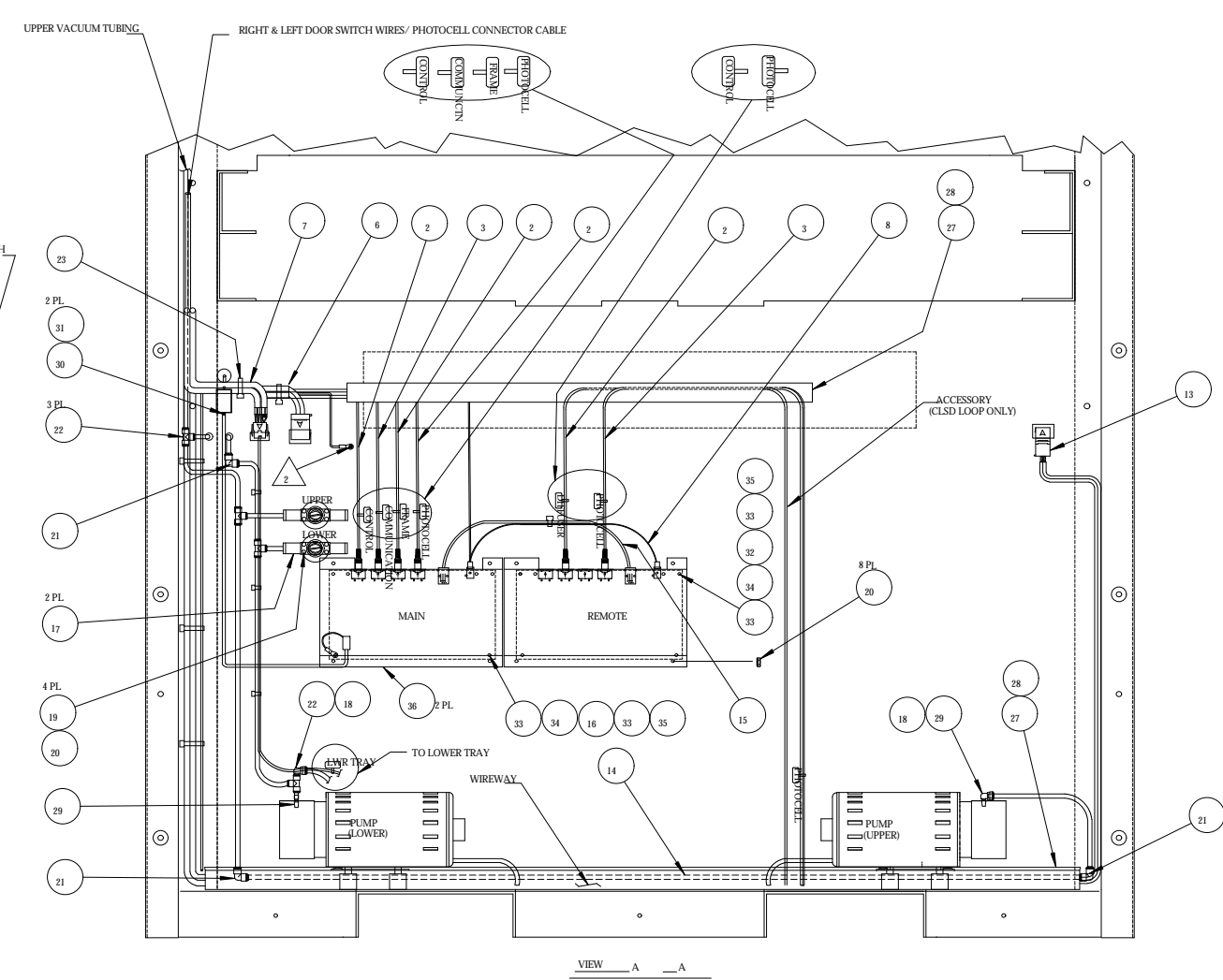
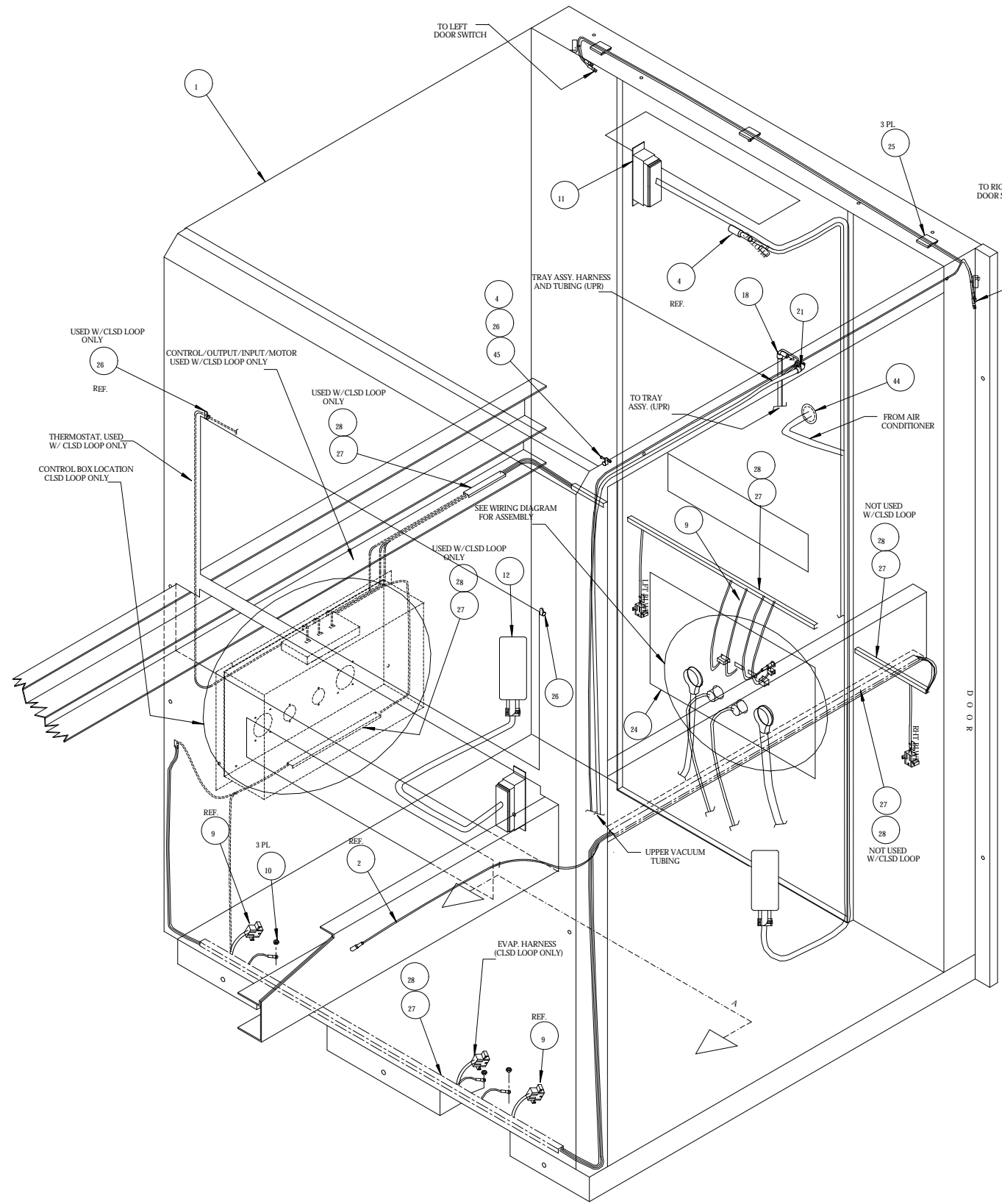

ITEM	QTY	DESCRIPTION	PART NO.	QTY	DESCRIPTION	PART NO.
24	1	ASSEMBLY, CONTROL BOX	SEE B.O.M.			
23	25	NSI NYLON TIE UV RESISTANT	44TIE10	47	1	LABEL, CAUTION
						15D2067
22	3	TEE, UNION, 3/8 TUBING	43FT09	46	1	LABEL, AP 30 SERIAL No.
						SEE B.O.M.
21	4	ELBOW, UNION, 3/8 TUBING	43FT07	45	1	STANDOFF #10 X .50 (ALUM.)
						44HHS543
20	11	NSI #6 KEP NUT ZINC	41-06NKP	44	-	CONTINUOUS GROMMET
						44RU802
19	4	NSI 6-32 X 1-1/4 PPMS ZINC	41-06PPS1.25	43	12	NSI MARKER TIE, 4"
						44TIE09
18	3	ELBOW PLUG-IN 3/8 O.D.	43FT 08	42	2	NSI 1/4 - 20 LOCKNUT NYLON
						41B40NLN
17	2	VALVE, VACUUM RELIEF	49VAV01	41	18	NSI 1/4 SAE FLAT WASHER
						41-40WFR
16	1	ACCUPRINT PCB-MASTER	64M441E-APM	40	2	WASHER SPLIT LOCK 1/4"
						41-F0WLS
15	1	CABLE, TELECOM, 6 PIN	16D2621B00	39	2	NSI 1/4 - 20 X 5/8 SOCKET BHD
						41BP5HC.62
14	-	TUBING, 3/8 O.D.	49DUC23	38	1	DRIP PAN, AIR
						11D2619A15
13	1	HARNESS, EMERGENCY SW-EXT	16D2495A00	37	1	AIR CONDITIONER ASSEMBLY
						SEE B.O.M.
12	1	INTERCONNECT CABEL 5 FT.	16D957.5	36	2	COVER, PCBA CONTROL BOX
						11D2272A17
11	2	INTERCONNECT CABEL 10 FT.	16D957-10	35	2	NSI 6-32 X 3/16 PPMS ZINC
						41-06PPS.18
10	3	NSI 10-32 KEP NUT ZINC	41-12NKP	34	2	NSI 6-32 X .312 HEX THRD SPCR
						42HHS9282
9	1	CABLE, VAC. PUMP/DELAY	16D2740A00	33	4	NSI #6 INTERNAL LOCK WASHER
						41-06WLS
8	1	HARNESS, PCB PWR - AP30/OV33	16D2651A00	32	1	ACCUPRINT PCB - REMOTE
						64M441E-APR
7	1	HARNESS, SWITCHES -AP30	16D2487A00	31	2	NSI 4-32 X 1.0 PPMS ZINC
						41-04PPS1.0
6	1	HARNESS, ACCESSORY - AP30	16D2469A00	30	2	NSI 4-40 HEX NUT ZINC
						41-04NHX
5	1	GROUND WIRE, FRAME	16D2182A00	29	2	VAC. PUMP FITTING
						SEE B.O.M.
4	1	NSI 10-32 X 3/8 PHIL PAN BLK	41B12PPS.37	28	-	WIREWAY COVER
						SEE B.O.M.
3	2	CONNECTOR CABLE 8 FEET	16D1003A08	27	-	WIREWAY (SELF-ADHESIVE)
						SEE B.O.M.
2	4	CONNECTING CABLE, QC5 (6'-0")	16D1003A06	26	2	NSI CLAMP, 3/8" O.D. 1/2"
						42HHS8914
1	1	CABINET, WELDMENT	63D1650A00	25	3	HEYCO, ADHESIVE.MNT.
						44PAD07

# Base Assembly Diagram

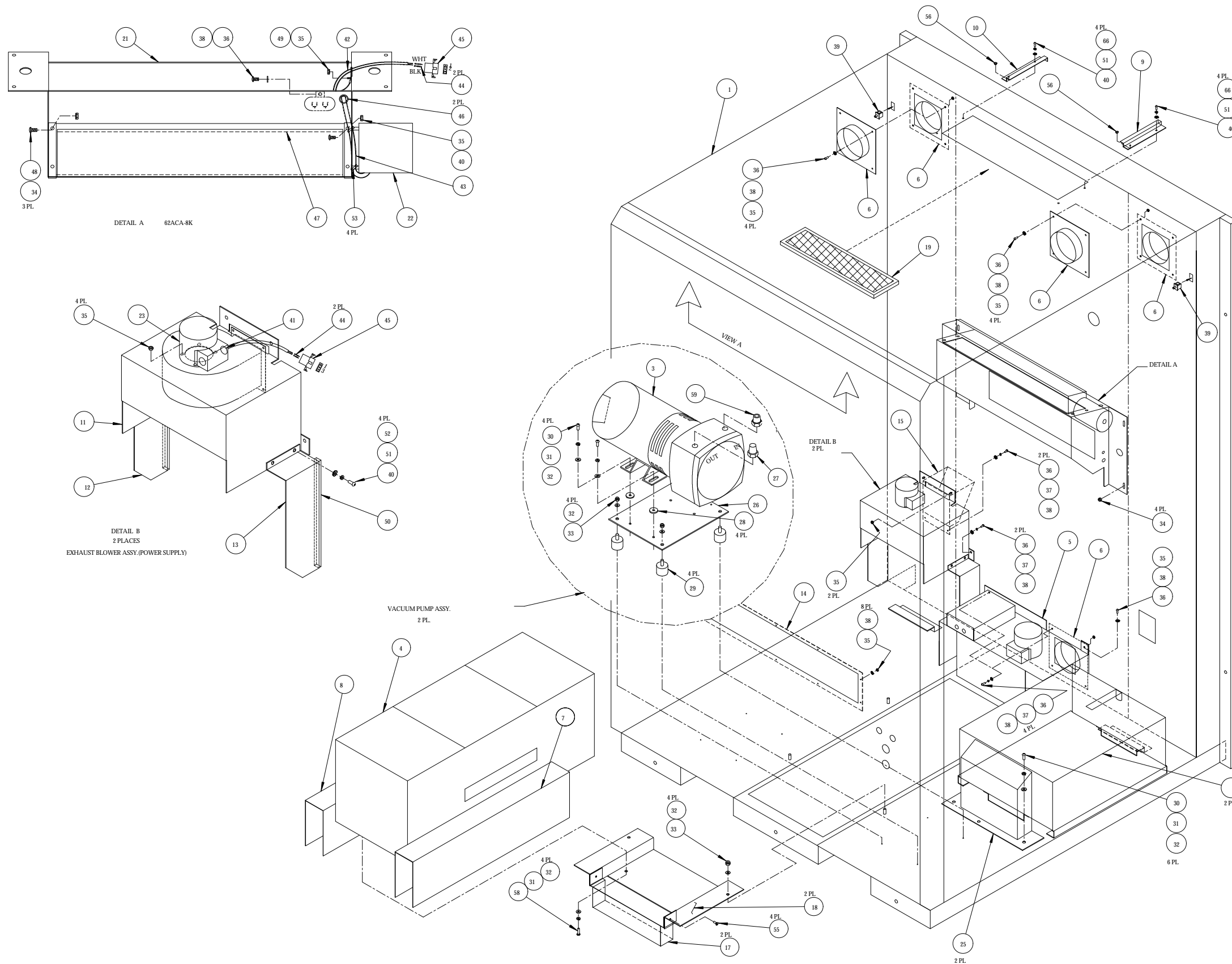

67	4	NSI 8-32 X 3/8 PHIL PAN MS BLK	41B08PPS.37
66	24	NSI #6 FLAT WASHER SAE	41-06WFR
65	4	EXT. REFL. SIDE(G)	11D2362B00
64	4	AP30 EXT. REFL. FRONT(G)	11D2361B00
63	16	NSI 6-32 X 5/16 PPMS ZINC	41-06PPS.31
62	1	HF1 BLOWER, ASSEMBLY	SEE B.O.M.
61	1	DUCTING, ALUM. 4" DIAM. W/HOSE	49DCT04
60	2	INTAKE, UPPER 5K	11D1670A02
59	2	CONNECTOR, MALE 3/8 TUBING	SEE B.O.M.
58	4	1/4 - 20 X 3/4 HEX HD BOLT	41-F0HFX.75
57	2	CABLE, VAC. PUMP	18D274A00
56	6	NSI 6-32 KEP NUT ZINC	41-06NKP
55	4	NSI 8-32 X 3/8 PHIL FLAT MS BLK	41B06PF2.37
54	2	BRACKET, DOOR SWITCH	11D2192A62
53	4	NSI CABLE TIE, UV 4"	44TIE08
52	16	NSI #6 FLAT, BLACK WASHER	41B06WFR
51	24	NSI #6 SPLIT LOCK WASHER	41-06WLS
50	17	GASKET, 1/16 THICK 1/2 WIDE	44GKT01
49	1	RING TERM. INS. 16-14 #8	51R11FE
48	3	NSI 10-32 X 3/8 PPMS BLACK	41B12PPS.37
47	37	TRIM-LOCK	48TRM02
46	2	NSI GRUMMET, RUBBER 3/4X	42HHS2175
45	3	RECEPTACLE 3 PIN	53RC P08
44	6	TERMINAL FEMALE 18-22 AWG.	51TML02
43	20	HEAT SHRINK TUBING, 1/2"	49DCT01
42	16	HEAT SHRINK TUBING, 1/8"	49DCT02
41	2	CABLE CLAMP, 1/2"	49CLM01
40	18	NSI 6-32 X 3/8 PHIL PAN MS BLK	41B06PPS.37
39	2	SWITCH, INTERLOCK	55SW46
38	38	NSI #8 FLAT WASHER SAE	41-08WFR
37	16	NSI #8 SPLIT LOCK WASHER	41-08WLS
36	19	NSI 8-32 X 1/2 PHIL PAN MS BLK	41B08PPS.50
35	27	NSI 8-32 KEP NUT ZINC	41-08NKP
34	7	NSI 10-32 KEP NUT ZINC	41-12NKP
33	12	NSI 1/4 X 20 LOCKNUT NYLON INS.	41B40NLN
32	22	NSI 1/4 SAE FLAT WASHER	41-40WFR
31	22	WASHER SPLIT LOCK 1/4"	41-F0WLS
30	14	1/4-20 X 5/8 SOCKET BTN HD BLK	41BFO5HC.62
29	8	ISOLATION MOUNT 1/4-20	44MNT03
28	8	RUBBER WASHER	13D2170
27	2	MUFFLER	39MUF01
26	2	PLATE, PUMP	11D1633A02
25	2	AIR DUCT (POWER SUPPLY) AP30	11D1668A02
24	2	BRACKET, AP30 LAMPHEAD	11D1647A62
23	2	BLOWER, MOTOR	39BLO05
22	1	BLOWER, TRANSFLOW, 220V50/60Hz	39BLO10
21	1	AIR DEFLECTOR TRANSFER	11D2071A17
20	1	INTAKE BOX	11D1917A02
19	1	FILTER, TOP AP30	19D1924A99
18	2	MOUNTING PAN- LOW L/H AP30	11D2913A17
17	2	INTAKE, LOW, LAMPHEAD	11D2620A17
16	2	BRACKET, DOOR SWITCH	11D2141A02
15	1	DEFLECTOR, AIR REAR AP30 OV33	11D2188A02
14	1	PLATE, FRONT PANEL, COVER	11D2141A02
13	2	EXTENSION, SIDE R.H.	11D2104B02
12	2	EXTENSION, SIDE L.H.	11D2104A02
11	2	BOX EXHAUST (POWER SUPPLY)	11D2103A17
10	1	BRACKET, FILTER HOLDER LT	11D1939B62
9	1	BRACKET, FILTER HOLDER RT	11D1939A62
8	1	CHANNEL, HOT AIR, LEFT	11D1661B17
7	1	CHANNEL, HOT AIR, RIGHT	11D1661A17
6	5	FLANGEPLATE, HF1 AP30-OV33-34	11D1648A02
5	1	EXHAUST BLOWER, 230V/60	62B2386A00
4	2	LAMPHEAD ASSEMBLY	SEE B.O.M.
3	2	VACUUM PUMP	SEE B.O.M.
2	2	POWER SUPPLY ASSEMBLY	SEE B.O.M.
1	1	CABINET, WELDMENT	63D1650A00
ITEM	QTY	DESCRIPTION	PART NO.



# 13. Light Source

## Component Layout

### Lamphead for AL 54 and AL 64 50/60Hz

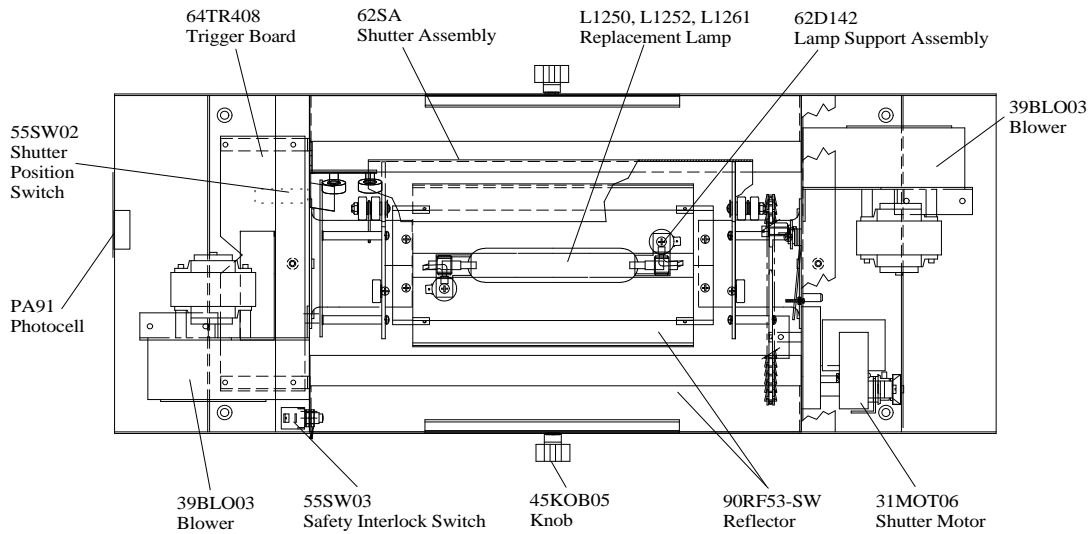

### Power Supply for AL 54 60Hz

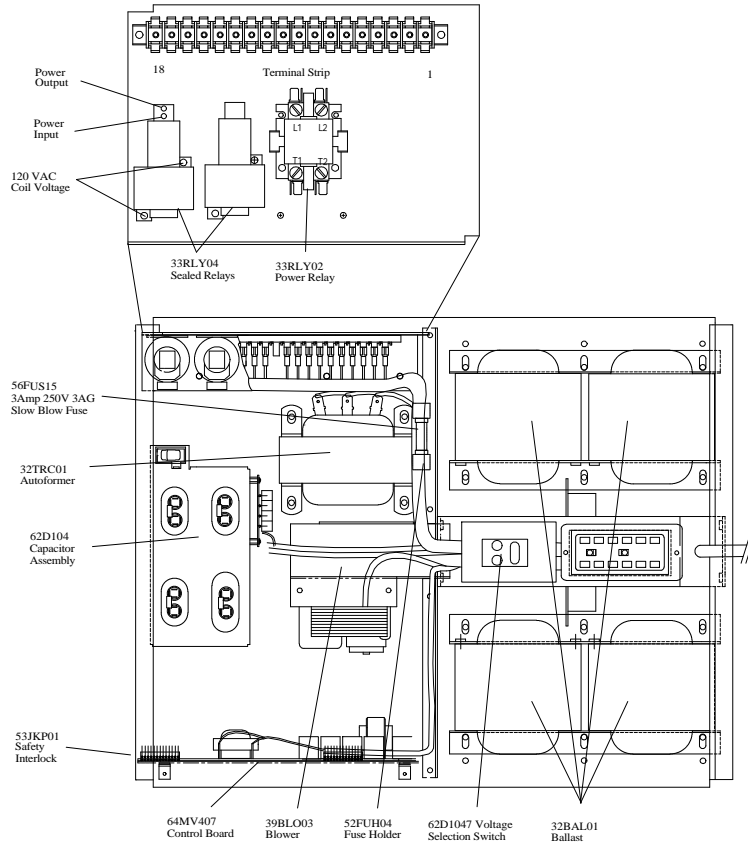

## Power Supply for AL 54-480 60Hz

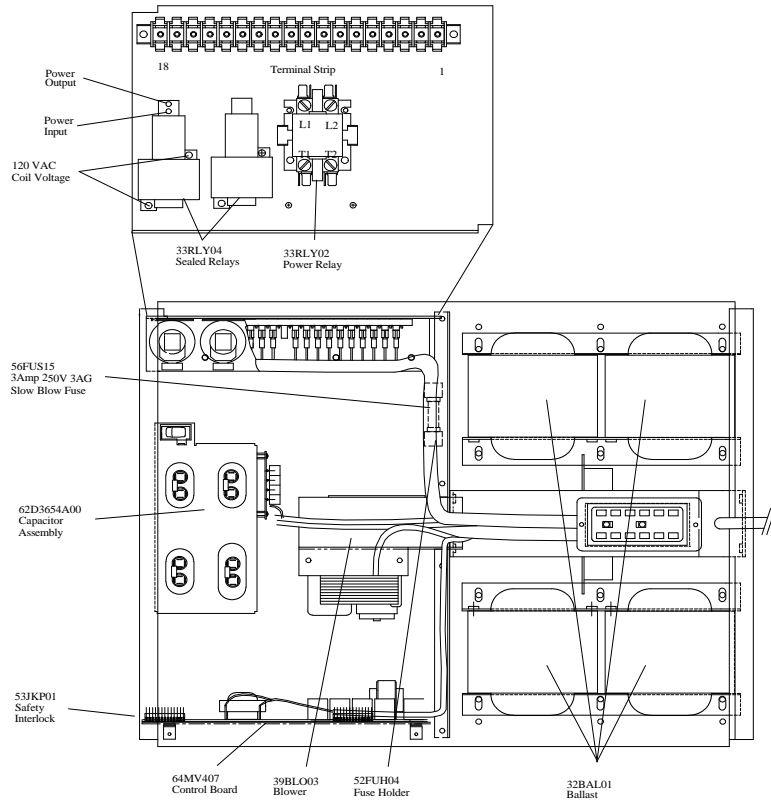

## Power Supply for AL 64 50Hz

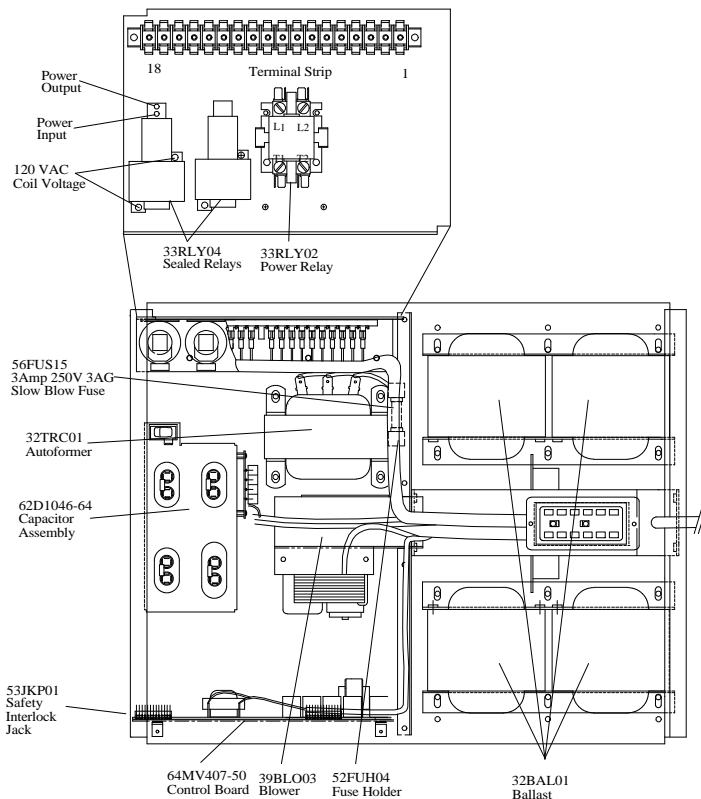

## Lamphead for AL 84 and AL 94 50/60Hz

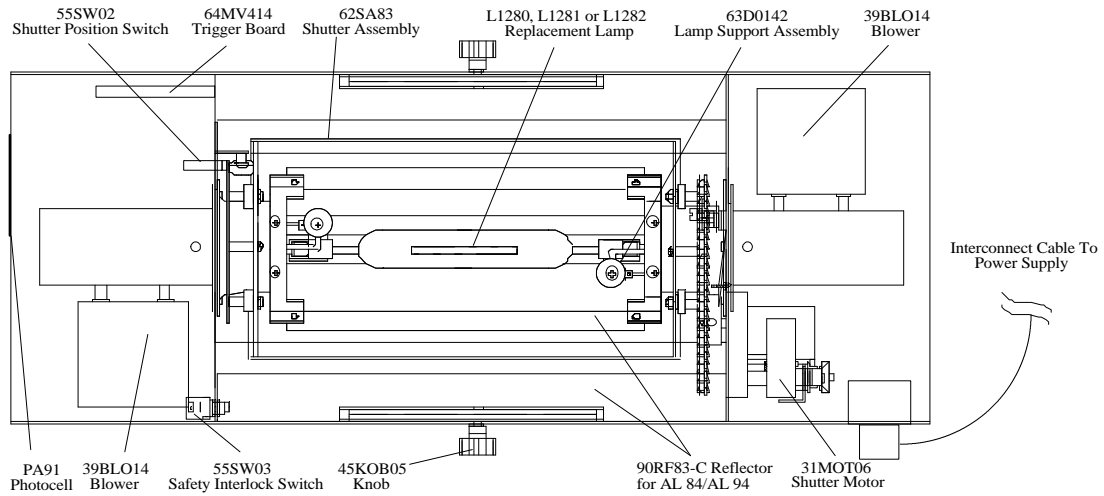

## Power Supply for AL 84 60Hz

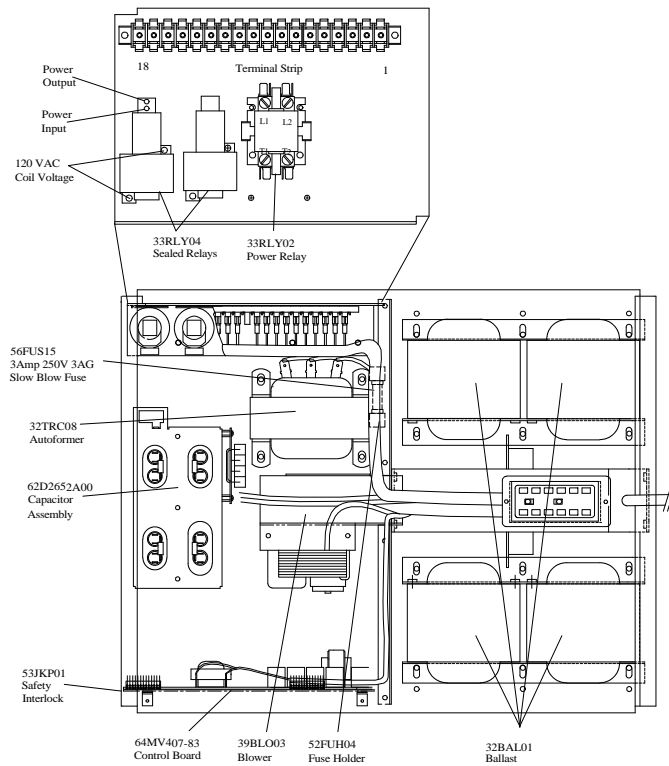

## Power Supply for AL 84-480 60Hz

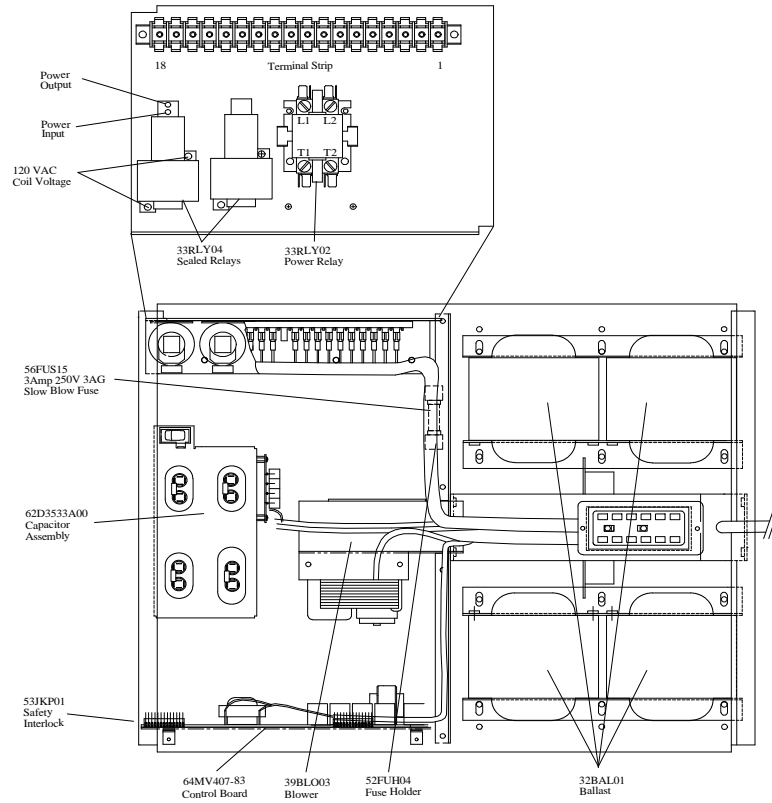

## Power Supply for AL 94 50Hz

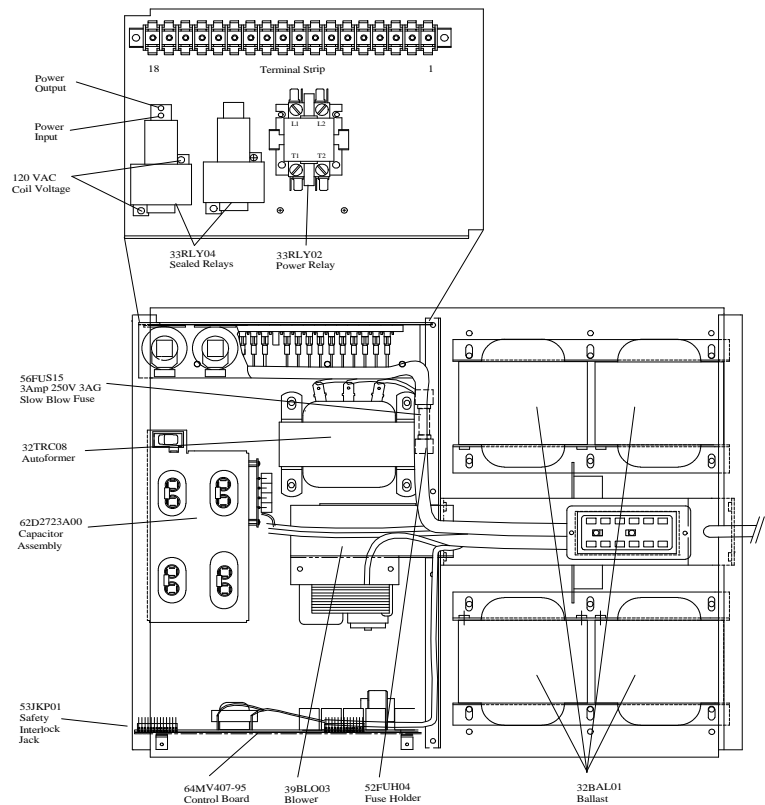

## Ballast/Tap Switch Wiring

### AL 54 Ballast / Tap Switch Wiring

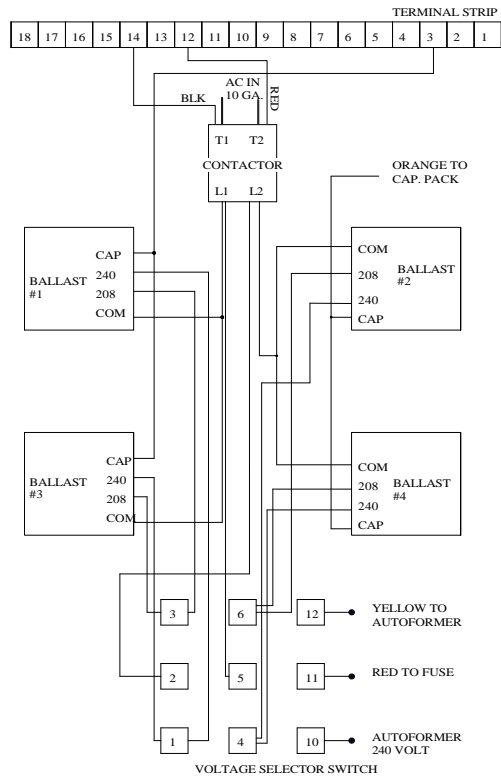

### AL 54-480 Ballast Wiring

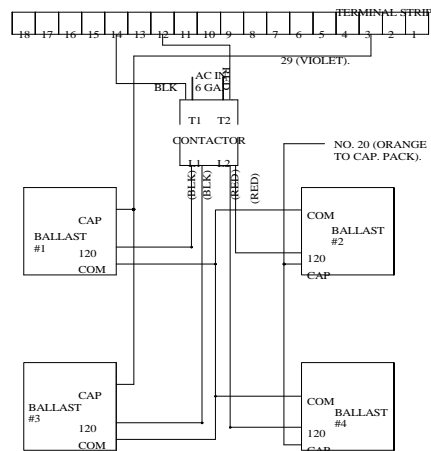

## AL 64 Ballast Wiring

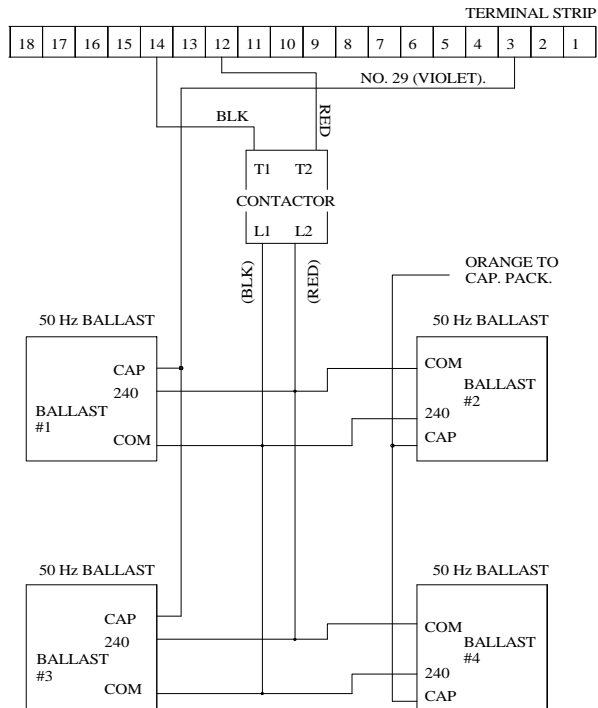

## AL 94 Ballast Wiring

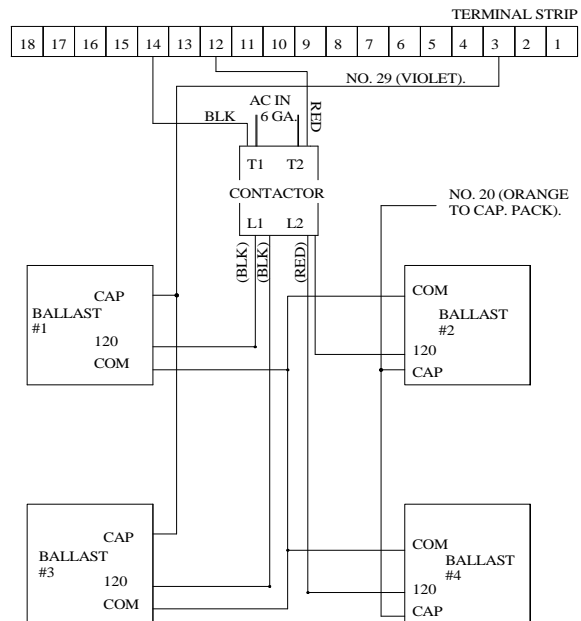

## AL 84 Ballast / Tap Switch Wiring

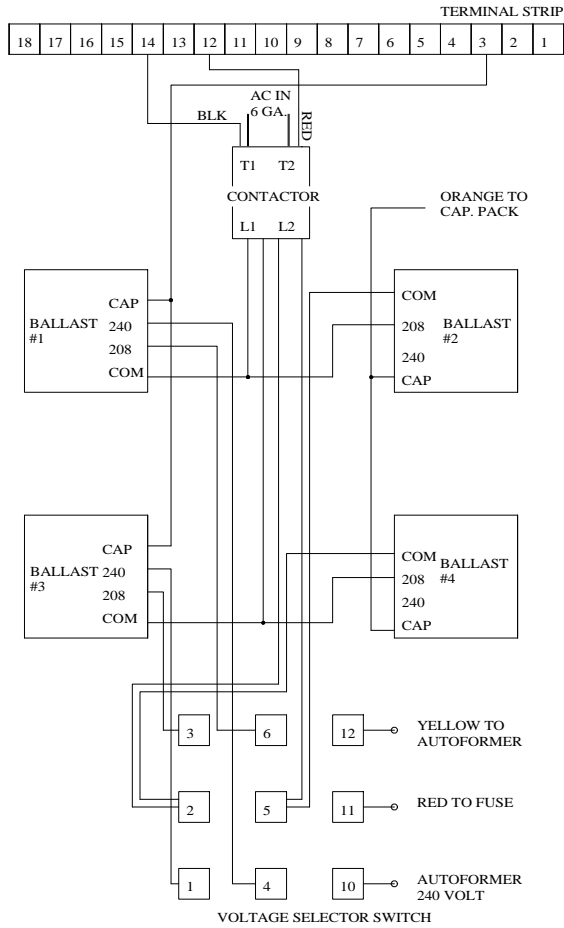

## AL 84-480 Ballast Wiring

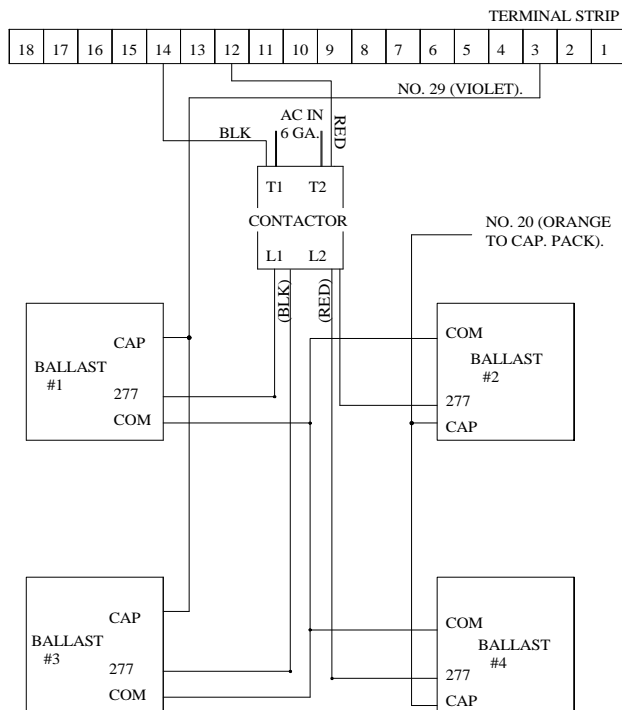

### **Path of Power to the PC Board**

- This section is useful when there is no power reaching the PC board (no LEDs lighted). Before tracing the power, check the fuse on the PC board and the incoming power.
- On 240V equipment, the power cord enters the rear of the unit. The two hot conductors are connected by wire nuts to wires that are in turn connected to the front of a terminal strip. One of these two wires passes through a fuse and on 60 Hz units is then connected to a voltage selector switch, then is connected to taps on a step-down autotransformer. This transformer is located under the terminal strip on the component bracket near the dividing wall. The transformer tap marked 120V becomes the unit common and returns to the terminal strip. The other line wire is connected to the transformer common and becomes the hot 120V lead to the PC Board and also returns to the terminal strip. The power is distributed from the strip and a pair of wires goes to the PC board.

### **Interlock System**

- The internal interlock system serves two purposes. The first is for operator safety by insuring the safety glass is in place before operation. This glass filters short UV radiation and covers the high voltage lamp terminals. This interlock also protects from overheating by traveling through two thermostats in the lamp head. There is also an outlet on some equipment marked “interlock” and is not used in this equipment.
- The internal interlock is a loop that travels through the light head, passing through the glass switch and two thermostats. This interlock is in series with the control circuit of the large relays in the power supply. When the interlock is opened, the relays will open and cut the power to the lamp terminals. The PC board senses the drop in voltage and closes the shutter.
- The first place to check is the glass switch. The switch lever is located near the edge of the glass on the end of the lamp where the cable enters. By releasing the glass, the lever can be seen. If the lever can slip past the glass, it should be bent slightly toward the reflector. If the switch is closed, the loop can be traced. First measure the voltage between lamp wires (#4 AC Common) and wire (#10 Interlock). The presence of voltage between these terminals indicates an open loop. This loop travels to the lamp head on wire (#10), then to the glass switch, the far end thermostat, the near end thermostat and terminates on wire (#4). The thermostats are mounted in the air tubes leading to the lamp. There are no splices in the air tubes.



## Lamp Voltage

The lamp voltage measurement can provide useful information for lamp striking, lamp output, and level switching information. The meter used to measure can cause different results. We use traditional needle movement meters in our factory, due to the trigger pulses on the lamp before striking. The waveforms are not sinusoidal, so different meters may produce different results. Here is a chart with typical measurements:

Lamp Voltage (Terminals 2 & 3)						Lamp Fan Voltage (Terminals 4 & 5)			
Model	Idle	Low	Med.	High	Trig.	Idle/Low	Med.	High	Trig.
AL54 w/L1250	200	200	230	270	500+	60-80	90-120	115-125	115-125
AL54 w/L1252	200	200	230	270	500+	65-90	90-120	115-125	115-125
AL54 w/L1261	210	210	230	270	500+	65-90	90-120	115-125	115-125
AL64 w/L1250	200	200	230	270	500+	55-75	90-120	115-125	115-125
AL64 w/L1261	210	210	230	270	500+	65-90	90-120	115-125	115-125
AL64 w/L1252	200	200	230	270	500+	65-90	90-120	115-125	115-125
AL84 w/L1280	360-380	360-380	380-410	415-445	500+	75-95	90-120	115-125	115-125
AL84 w/L1281	400-430	400-430	425-500	460-530	500+	75-95	90-120	115-125	115-125
AL84 w/L1282	400-430	400-430	425-500	460-530	500+	75-95	90-120	115-125	115-125
AL94 w/L1280	360-380	360-380	380-410	415-445	500+	70-90	90-120	115-125	115-125
AL94 w/L1281	400-430	400-430	425-500	460-530	500+	65-90	90-120	115-125	115-125
AL94 w/L1282	400-430	400-430	425-500	460-530	500+	65-90	90-120	115-125	115-125

## Lamp Power Path

The basic path that the power to the lamp takes is almost identical for all units. The basic path is incoming line, main power relay, ballasts, capacitors, trigger board, and then the lamp. See the point to point wiring diagrams for each light source in Section 16.

## Trigger Board

A trigger board is provided in the light head to start the lamp. This board operates on demand by sensing the lamp voltage. This board can be heard when it is functioning, although the sound is faint. By turning the unit on and off, the sound can be compared during trigger and cool-down. In both situations, the fans are running full speed. The fans may be disabled by pulling the blue wire from terminal #5 to aid in determining if the trigger board is functioning. Use caution that the lamp doesn't run without cooling.

The trigger board is located in the lamp head, in the end where the cable enters. It is located in the cool air path inside the air plenum. One lamp lead is in series with the trigger transformer [(1) input (3) output], the other lamp lead (2) is used to sense the lamp voltage. Outside the unit, the board can be tested by putting 350-750VAC between terminals [(1) and (3)], and causing an arc from terminal (3) to terminal (1). This arc should be .015 or greater.

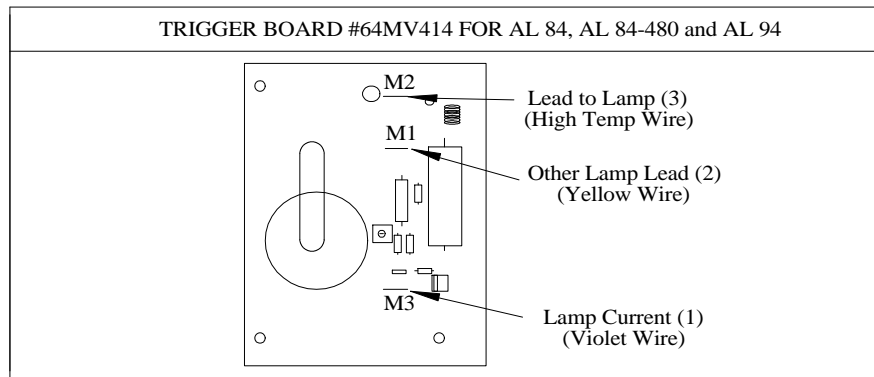
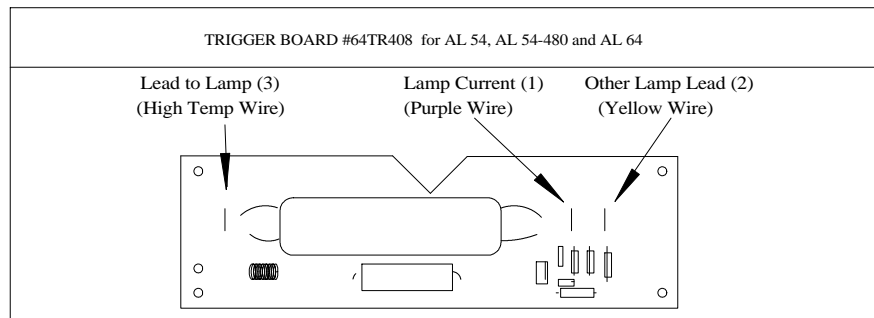

## Capacitors and Level Switching

The capacitors pass all the current that flows through the lamp. They are also used to switch power levels.

- The capacitors for the AL 54, AL 54-480, AL 64, AL 84, AL 84-480, AL 94, are divided into three sections. All units have one or two idle capacitors, they are connected with a yellow wire. High power capacitors are switched in during warm-up and high power exposures. There are two high power capacitors connected with a blue wire. All capacitors have an orange wire which acts as a common.
- The capacitors for high and medium levels are pulled in with relays during warm-up and exposures. The medium relay will pull in to select medium power. In this case the medium relay will also always pull in for high power exposures.
- The capacitors set the operating current of the lamp. If the lamp output has changed rapidly, inspect the capacitors for swelling. The design of capacitor we use will burn open if it begins to short. A swollen capacitor should be replaced, and the unit should be tested to see that the capacitor did not damage the high or medium relay. To test the unit's ability to switch power levels, make a manual exposure, then switch between the power levels, noting the change in intensity. When switching down in power, allow the unit three seconds to respond.

### AL 54 Capacitor Assembly

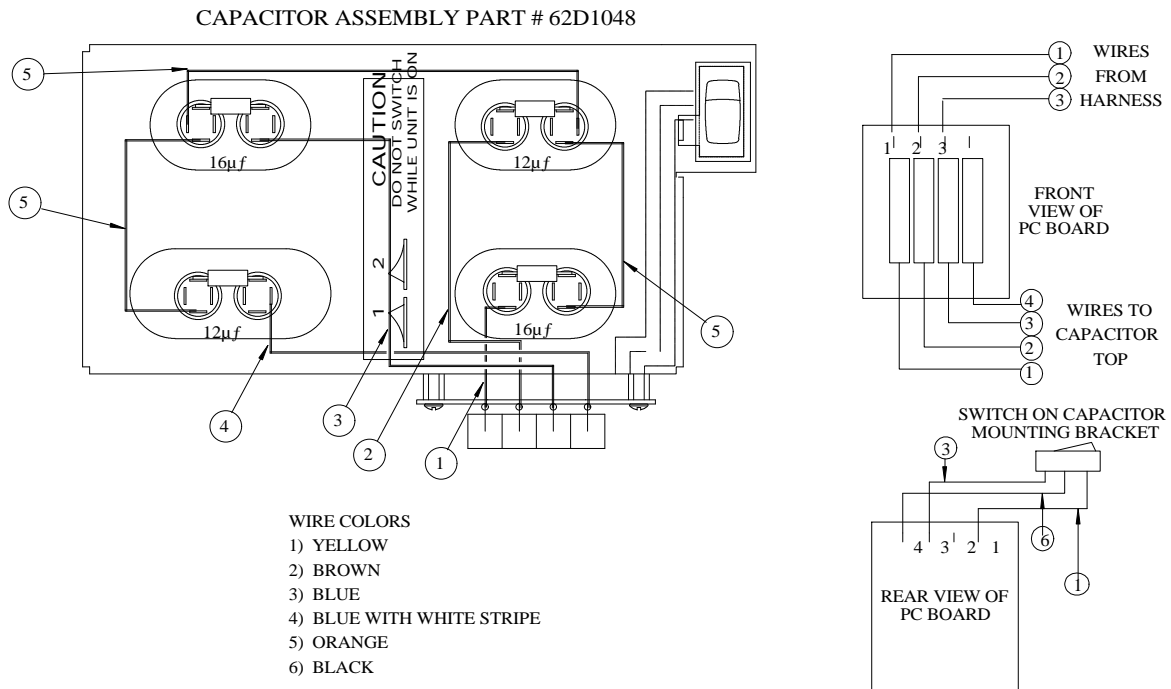

## AL 54-480 Capacitor Assembly

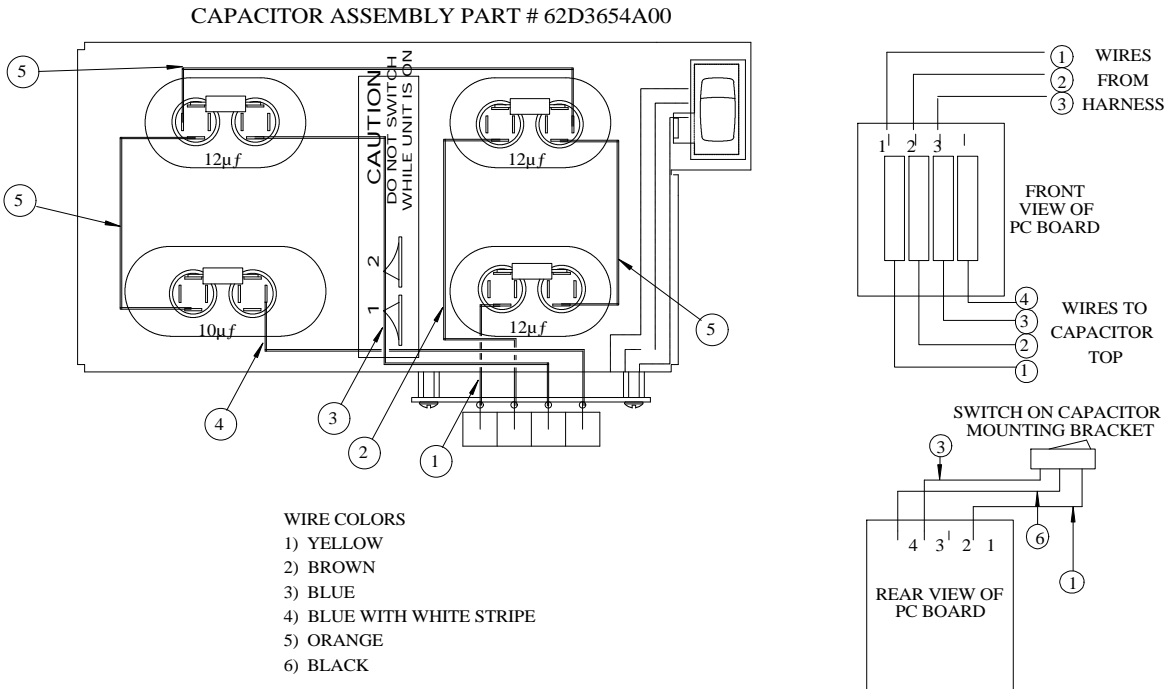

## AL 64 Capacitor Assembly

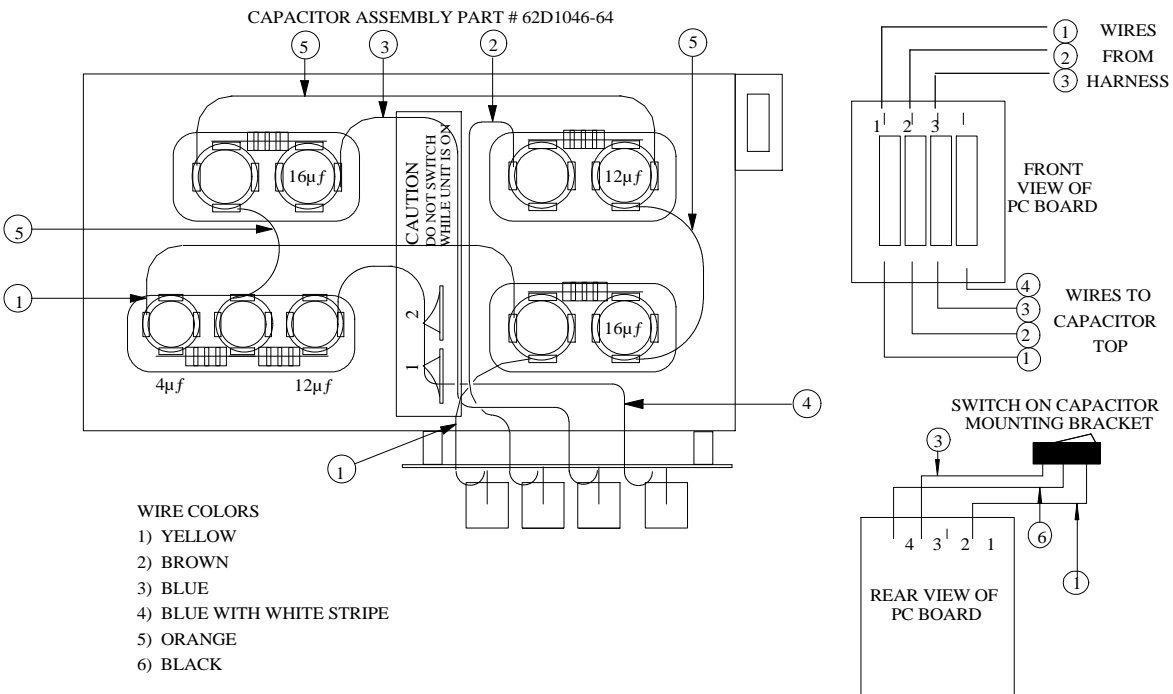

## AL 84 Capacitor Assembly

CAPACITOR ASSEMBLY PART # 62D2652A00

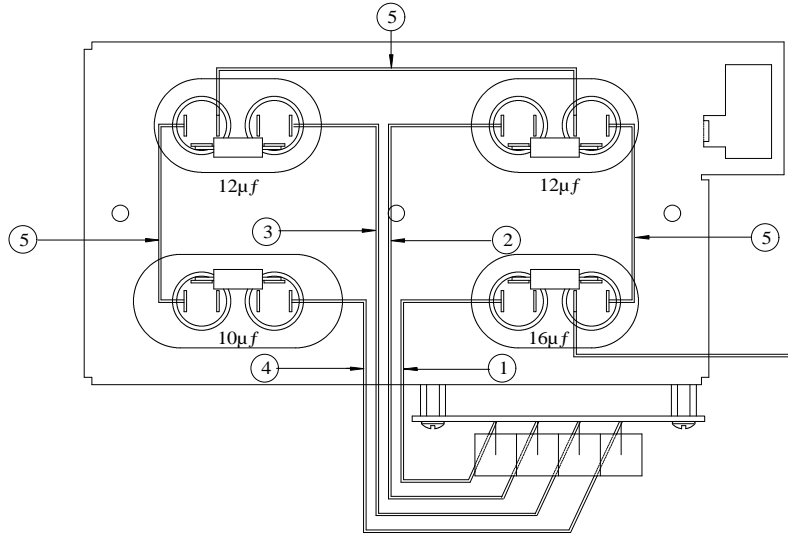

### WIRE COLORS

- 1) YELLOW
- 2) BROWN
- 3) BLUE
- 4) BLUE WITH WHITE STRIPE
- 5) ORANGE

## AL 84-480 Capacitor Assembly

CAPACITOR ASSEMBLY PART # 62D3533A00

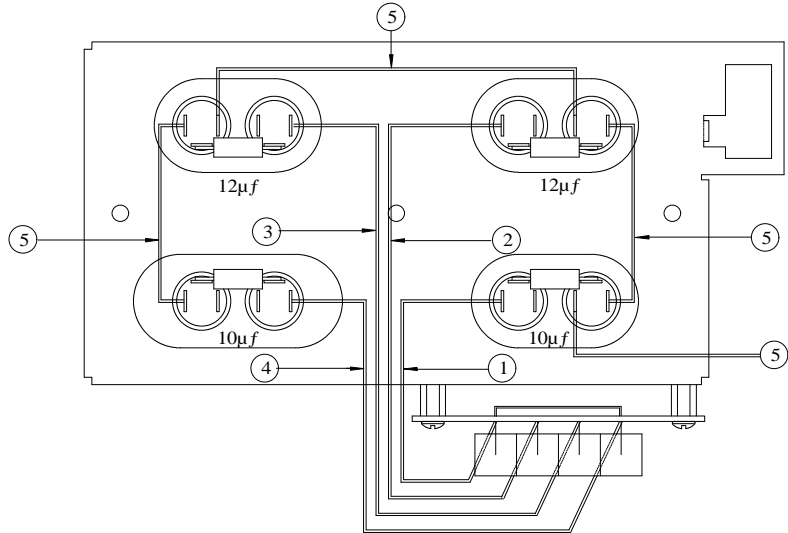

### WIRE COLORS

- 1) YELLOW
- 2) BROWN
- 3) BLUE
- 4) BLUE WITH WHITE STRIPE
- 5) ORANGE

# AL 94 Capacitor Assembly

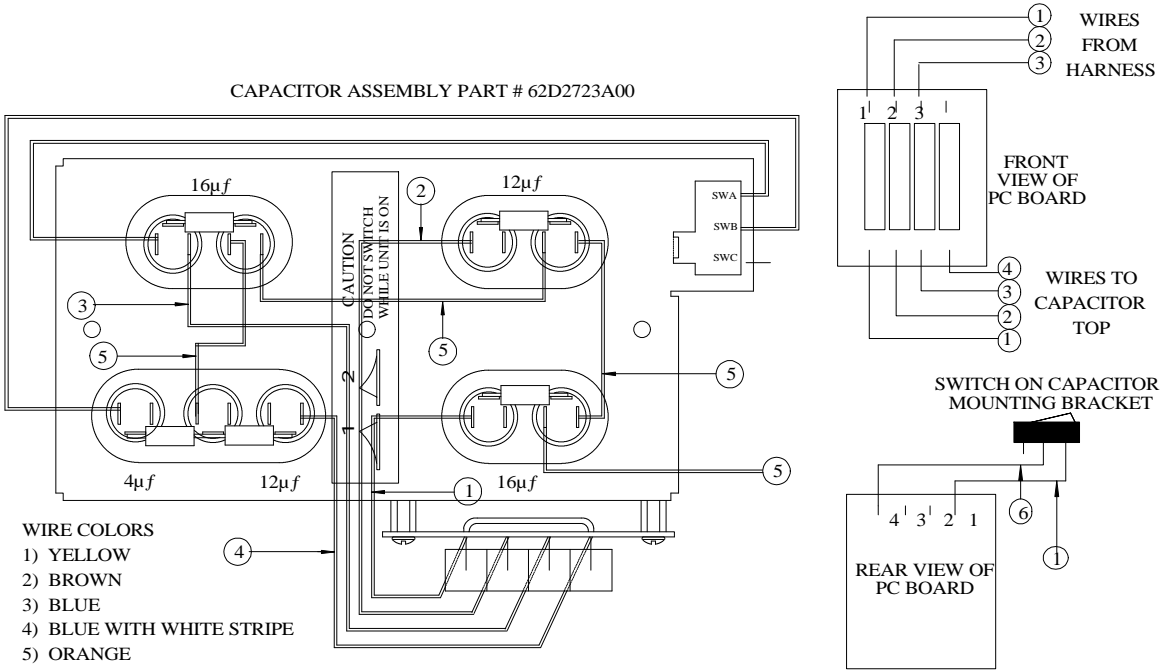

## Opening the Lamp Head

- Unplug the unit.
- Remove the glass and the four screws attaching the large outer reflector section.



**CAUTION** DO NOT TOUCH THE REFLECTOR SURFACE WITH YOUR HANDS.

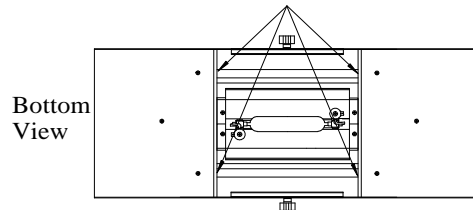

Remove the 2 center screws from the bottom side and the 2 screws from the top side of the lighthouse.

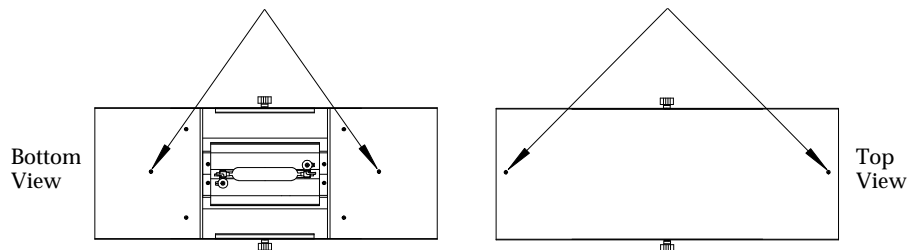

Remove the 6 screws from each side of the lamphead and remove the two endcaps. On 8kW lampheads you can now access the trigger board and shutter position switch that are located at the opposite end from the shutter motor under the air plenum plate.

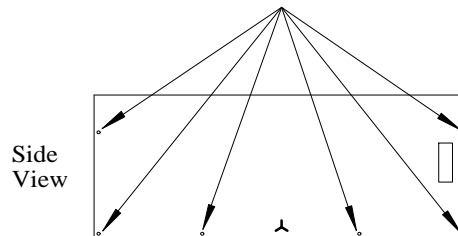

On 5kW lampheads remove the 5 screws from the air plenum plate to remove it. The trigger board and shutter position switch are located at the opposite end from the shutter motor under the air plenum plate.

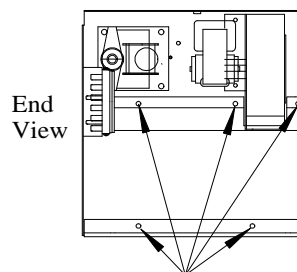

## **Shutter**

The shutter is controlled by the PC board, with information from a switch in the lamp head to provide position information. During cool-down and exposure, the shutter is open and during warm-up and idle, the shutter is closed.

The PC board compares the shutter position with the requested position. The shutter motor will run until the switch position matches. The shutter motor has a brake that is magnetically operated. Whenever the power is released from the motor, the brake falls into a slot. There is an LED on the PC board that lights whenever the shutter is being energized. (Look in the PC board pin section for a diagram of the LEDs).

## **Shutter Switch**

The switch provides shutter position information to the PC board. This switch is in the lamp end where the cable enters, inside the manifold cover. The cam is in the chamber with the shutter. A failure of the switch can cause the shutter to rotate continuously or erratically. Similar problems may be due to the shutter motor brake, the idle setting, or the PC board.

The switch contacts close when the shutter is fully open and remain closed until the shutter closes. This level can be measured on the terminal strip from terminal 9 (+) to terminal 7 (-). The level is 12 VDC when the shutter is closed, and 0 V when the shutter opens. The switch is in the lamp head on the end where the cable enters inside the air manifold on older units. On newer units we use the normally open contacts, COM contact and the center contact. We use the normally closed contacts, the two outside leads, not the center contact. This switch is adjustable on older units. We recommend scribing a line around the switch and the bracket, if replacement is necessary, to return to the same position. The switch roller should be centered on the cam and closed when the cam pushes the wheel on the switch halfway.

## **Shutter Brake**

The motor that drives the shutter has a brake that is magnetically operated. When the motor core magnetizes, it pulls a lever to release the brake. If the shutter coasts or rotates continuously, look at the shutter LED on the PC board. On early boards, where there are three LEDs in a row near the front of the power supply, it is the third from the front of the power supply. On the newer models, there are five in a row; it is the fourth from the front of the power supply. When this light goes out, the shutter brake should engage. If the shutter coasts, the brake may have failed. The shutter may coast to the point where the switch will switch again to cause the motor to energize. The LED on the board will flash if this occurs.



## Shutter Motor

The shutter motor is located in the lamp head on the side with the shutter drive chain. We recommend checking the power and signals from the switch and to the motor coil, before entering the lamp head. These items are covered in the preceding sections. Changing the shutter motor requires a Phillips screw driver and a  $\frac{3}{32}$ " Allen wrench.

- Remove the glass and outer reflector from the light head.
- Open the end of the light head, where the drive chain and the sprocket are located.
- There are four screws that hold the motor; two of them require access through holes in the sprocket. The shutter can be turned counterclockwise to access these screws, by pushing the brake on the motor.



**CAUTION** Turn the shutter only counterclockwise (looking from the motor end) or you may damage the shutter switch on the other end of the light.

- Remove the chain from the sprocket with care to keep tension. The chain has shortened links and will separate if slackened. If the chain opens, attach an end to the sprocket with tape or wire and revolve the shutter.
- Remove the motor sprocket by loosening the set screw.
- Remove the two wire nuts from the motor coil wires.
- Remove the four motor screws.

## Installing the Motor

- Mount the motor with four screws.
- Install the sprocket in line with the shutter sprocket and tighten.
- Install the chain on the sprockets.
- Set the chain to where it has  $\frac{3}{8}$ " side travel and tighten the two accessible motor screws lightly.



**CAUTION** Turn the shutter only counterclockwise (looking from the motor end) or you may damage the shutter switch on the other end of the light.

- Rotate the sprocket to tighten the other two screws and attach the wires.
- The shutter can be tested with the unit open by disconnecting one of the lamp leads and holding the interlock switch.



**CAUTION** **DO NOT light the lamp without the safety glass or when you are close to the bulb.**

## Shutter Removal

### LT1 lampheads

- Remove the 2 screws holding the air flow deflectors and remove them. Then reach through the air tube and remove the thermostat, then the high temp lamp lead (reaching through the bottom of the light a pair of needlenose pliers to remove it from the lamp support assembly makes this easier).

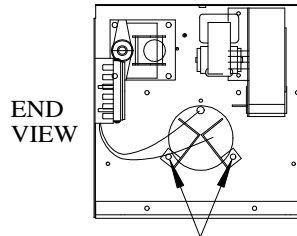

- Remove the 4 screws holding the rear reflector to the air tubes and remove the reflector and lamp from the lamphead.

**CAUTION** DO NOT TOUCH THE REFLECTOR SURFACE WITH YOUR HANDS.

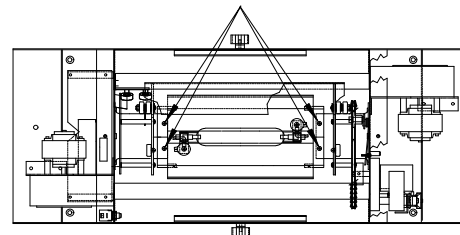

- Remove the top screw from the cooling tube on both sides. Compress the air tubes into the shutter assembly, remove the chain from the motor sprocket, then remove the shutter assembly.

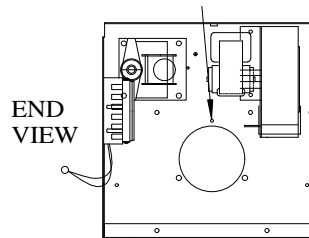

- Reassemble in reverse order.

**CAUTION** DO NOT TOUCH THE REFLECTOR SURFACE WITH YOUR HANDS.



# LT1 Shutter Assembly Drawing

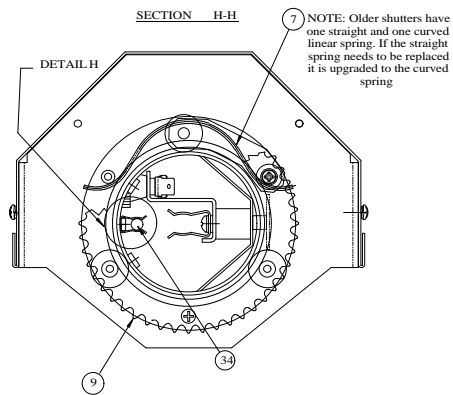
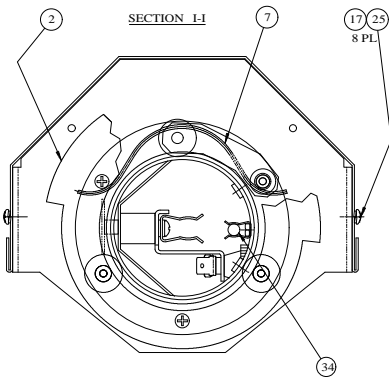
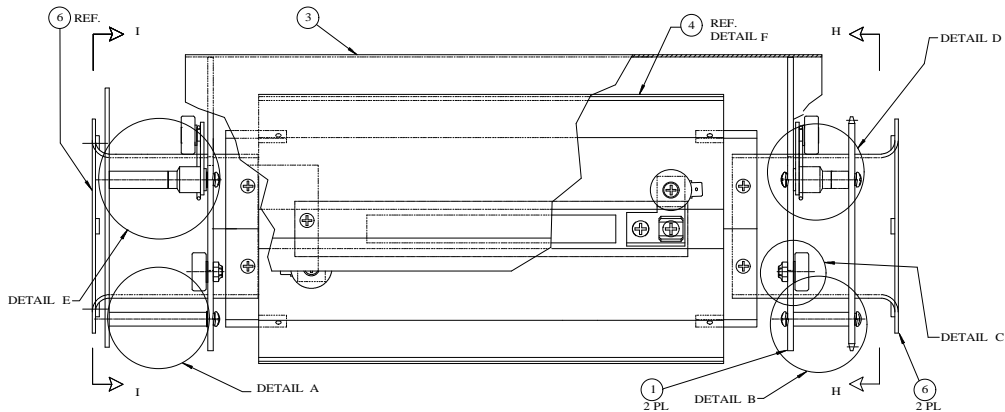
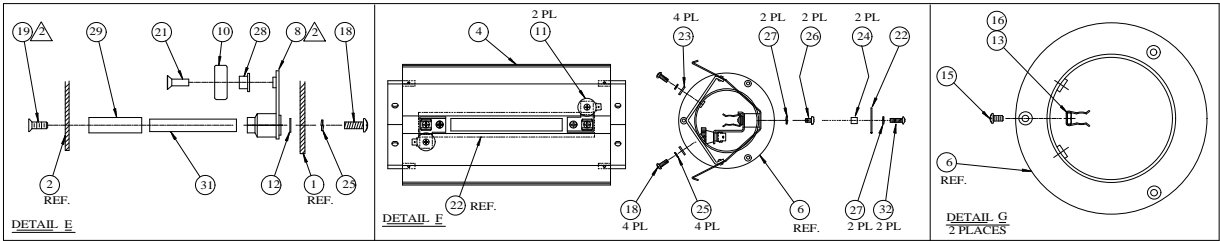

27	4	#8 WASHER, SPLIT LOCK	41-08WLS
26	2	#8-32X.25 SCREW, PHIL.PN.HD.	41-08PPS.25
25	21	#6 WASHER, SPLIT LOCK	41-06WLS
24	2	#8 X .250 ROUND SPACER	42HHS521
23	8	#6 FLAT WASHER	41-06WFR
22	1	BAFFLE, SHUTTER ASSEMBLY	11D878
21	2	6-32 X 7/16 SOC FLAT	41B06SHF.43
20	4	#6-32X.62 SCREW, 100° FLAT HD.	41B06SHF.62
19	3	#6-32X.37 SCREW, 100° FLAT HD.	41-06PF0.37
18	13	#6-32X.25 SCREW, PHIL.PN.HD.	41-06PPS.37
17	8	#6-32X.25 SCREW, PHIL.PN.HD.	41B06PPS.25
16	2	#4-40 NUT HEX	41-04NHX
15	2	#4-40X3/16 PPMZ ZINC	41-04PPS.18
14	3	#6-32X1.000 RD.THD SPACER	42HHS347
13	2	FUSE CLIP	43CLP02
12	3	#6 WASHER, LOCK INTERNAL	41-06WLI
11	2	LAMP SUPPORT ASSEMBLY	63D0142B00
10	6	BALL BEARING	12D3515A00
9	1	SPROCKET, DRIVE (MACHINED)	12D1998A99
8	2	IDLER ARM, SHUTTER	63D3530A62
7	2	SPRING, SHUTTER AL83	12D2060A07
6	2	AIR TUBE LT-1, AL25-53	12D0217A62
5	4	#6 X .180 ROUND SPACER	42HHS8500
4	1	REFLECTOR, INNER RF53	11D886
3	1	SHUTTER ASSEMBLY LT1	11D2206
2	1	TIMING DISC, LT-1	11D210A62
1	2	SHUTTER END	11D1949A71
ITM	QTY	DESCRIPTION	D3214B PART NO.

34	2	THERMOSTAT	56THM01
33	4	#6-32 NUT, FLEX LOCK	41-06NLM
32	2	#8-32 X 1/2 PPMZ ZINC	41-08PPS.50
31	3	#6-32 X 1.7 STANDOFF	42HHS8761W
30	1	SPACER, TUBING (SHORT)	12D3588B07
29	1	SPACER, TUBING (LONG)	12D3588A07
28	2	BUSHING, IDLER ARM	12D3550A62
ITM	QTY	DESCRIPTION	PART NO.

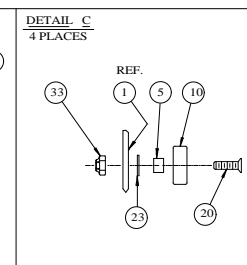
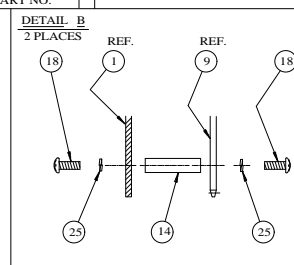
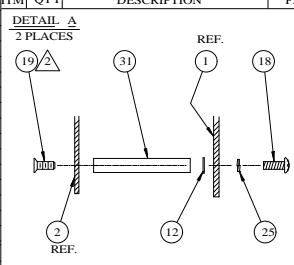
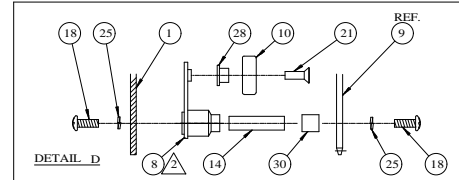

## LT8 lampheads

- Remove the four hex nuts mounting the blowers, disconnect the blower and thermostat wires.

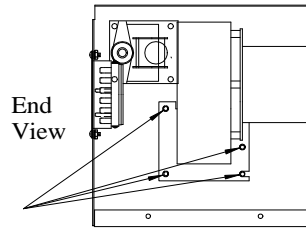

- Remove the four screws holding the rear reflector to the cooling tubes and remove the reflector and lamp from the lamp head.

**CAUTION** DO NOT TOUCH THE REFLECTOR SURFACE WITH YOUR HANDS.

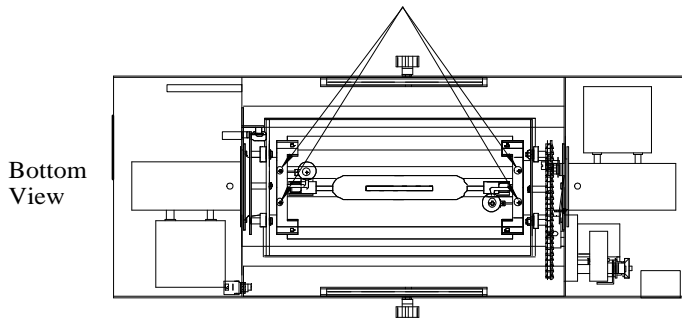

- Remove the three screws from the blower mounting plate to the cooling tubes on both sides. Compress the cooling tubes into the shutter assembly, remove the chain from the motor sprocket, then remove the shutter assembly.

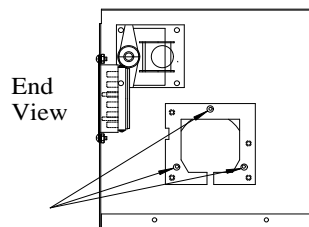

- Reassemble in reverse order.

**CAUTION** DO NOT TOUCH THE REFLECTOR SURFACE WITH YOUR HANDS.



# LT8 Shutter Assembly Drawing

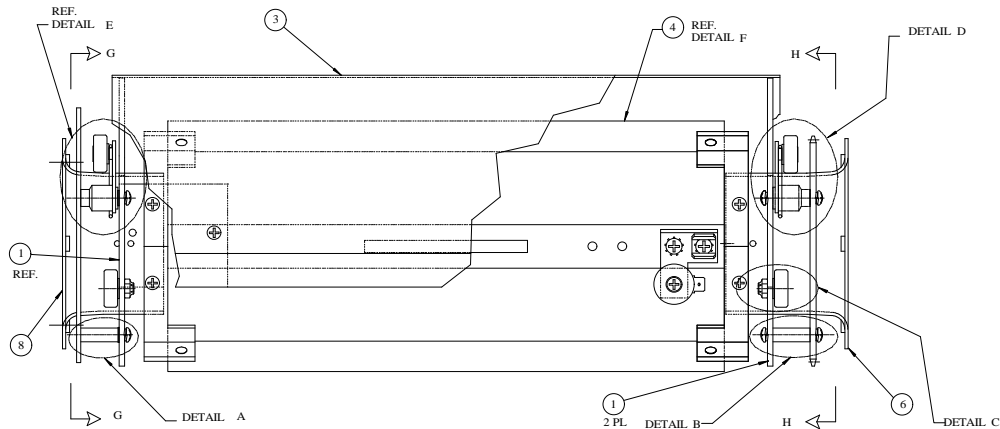
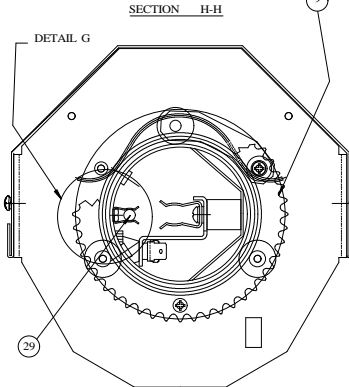
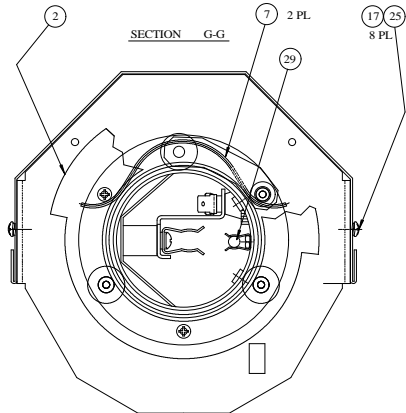
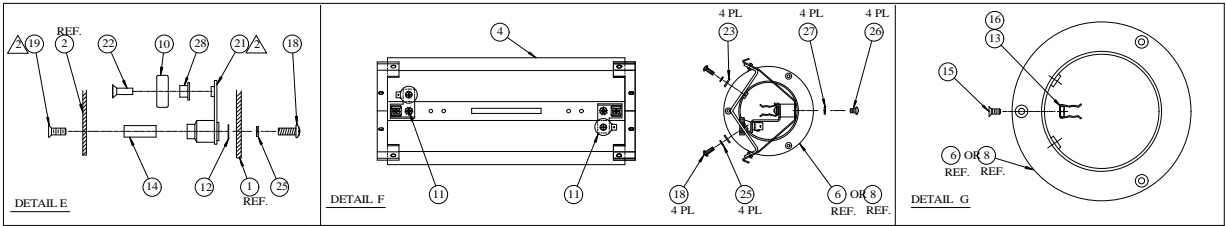

29	2	THERMOSTAT	56THM01
28	2	BUSHING, IDLER ARM	12D3550A62
27	4	#8 WASHER, SPLIT LOCK	41 08WLS
26	4	#8-32X.25 SCREW, PHIL.PN.HD.	41 08PPS.25
25	21	#6 WASHER, SPLIT LOCK	41 06WLS
24	4	#6-32 NUT, FLEX LOCK	41 06NLM
23	4	#6 FLAT WASHER	41 06WFR
22	2	6-32 X 7/16 SOC FLAT	41B06SHF.43
21	2	IDLER ARM, SHUTTER	63D3530A62
20	4	#6-32X.62 SCREW, 100° FLAT HD.	41B06SHF.62
19	3	#6-32X.37 SCREW, 100° FLAT HD.	41 06PF0.37
18	13	#6-32X.37 SCREW, PHIL.PN.HD.	41B06PPS.37
17	8	#6-32X.25 SCREW, PHIL.PN.HD.	41B06PPS.25
16	2	#4-40 NUT HEX	41 04NHX
15	2	#4-40X.25 SCREW, 100° FLAT HD.	41B04PF025
14	6	#6-32X.687 RD. SPACER	42HHS8779
13	2	FUSE CLIP	43CLP02
12	3	#6 WASHER, LOCK INTERNAL	41 06WLI
11	2	LAMP SUPPORT ASSEMBLY	63D0142B03
10	6	BEARING, BALL	SEE BOM
9	1	SPROCKET, DRIVE (MACHINED)	12D1998A99
8	1	AIR TUBE, FRONT	12D1874A62
7	2	SPRING, SHUTTER AL83	12D2060A07
6	1	AIR TUBE, DRIVE	12D1873A62
5	4	#6 X .187 ROUND SPACER	42HHS8500
4	1	REFLECTOR, INNER, RF83-SW-G	11D1876B99
3	1	LT8 SHUTTER-REFLECTOR ASS'Y	11D2216
2	1	TIMING DISC, LT-1	11D0210A62
1	2	SHUTTER END, PHOTOCELL, SLOT	11D3974A71
ITM	QTY	DESCRIPTION D4358A	PART NO.

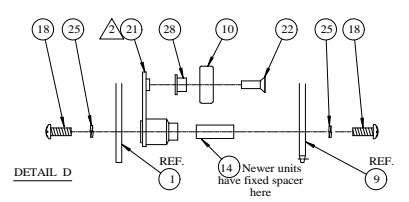

APPLY LOCTITE 242 TO THREADS WHERE INDICATED.

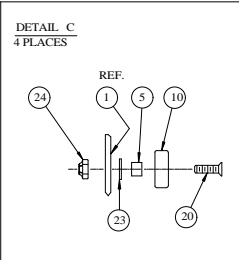
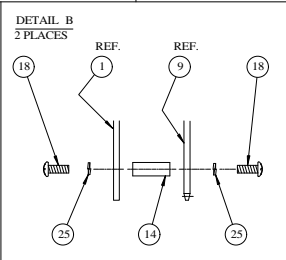
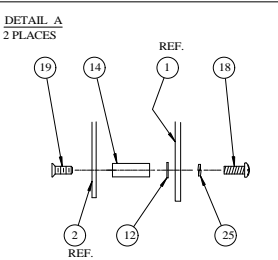

## Idle Setting

- The idle level occurs between exposures and low power exposures. The idle setting determines the power and temperature of the lamp, while at idle. It also allows for much lower idle power than was ever attainable before.
- This lower power level provides a wider light output range, low power consumption, lower heat generation, and increased lamp life. At low power levels, the lamps normally become unstable. If over cooled, they begin to dissipate less energy, which causes them to cool more. This can continue until they extinguish. When lamps become hotter at idle, they become more efficient and dissipate more energy, making them hotter still. This becomes stable, and is commonly done in conventional light sources, but will shorten the life of the lamp and wastes energy. We have chosen to servo the cooling, by sensing the lamp condition and adjusting the cooling to regulate the idle temperature.
- The idle setting is done at the factory and is rarely necessary in the field. Always check all other causes of problems before changing the setting.
- If the lamp becomes too cool during operation, the board will sense this level and initiate a warm-up cycle. During warm-up, the shutter will close and will not open until the unit is sufficiently warm. A symptom of this is: after an exposure is started, the shutter will open, then close again for several seconds, before finishing the exposure. This should only happen if the unit is left for a period of time. Successive rapid exposures would not fail, since it takes many minutes for the unit to over cool. This over cooling situation could also be due to a bad idle capacitor, which would not allow sufficient energy to the lamp to keep it warm.
- After checking the capacitors, mark the factory setting of the trimpot that is located on the back side of the PC board. The trimpot sets the power level that the lamp idles at. Turning the trimpot counterclockwise will first slow the lamp blowers. As the lamp reaches the new idle setting, the blowers will speed up to hold the new level. Setting with a meter is done by measuring the lamp voltage on terminals 2 and 3. See section on Lamp Voltage for proper idle voltage setting. The voltage will increase with a counterclockwise and decrease with a clockwise direction. This voltage change is a secondary effect after the lamp has responded to the change in cooling. The changes should be done in small increments, waiting between adjustment for the voltage to stabilize.
- The idle setting affects the power that the lamp attains on warm-up cycle, before switching to idle and the idle temperature of the lamp. If the setting is too high (too far counterclockwise), the unit will run at high power, with no cooling until the thermostats switch the unit off. The idle temperature of the lamp affects its life and reliability. If the idle setting is too low (too far clockwise ), the lamp will be slow to come to power for exposures, and the unit may close the shutter, after the unit has begun to expose to warm back to power. For these reasons, please take care when making this adjustment and check other problems first.

## **Lamp Head Blowers**

- The lamp head blowers are controlled by the printed circuit board to provide the correct cooling to the lamp. During warm-up, the blowers are off or run very slowly. At idle and during low exposure, the blowers vary in speed. Both at high exposure and cool-down the blowers run at full speed.
- A symptom of a defective blower would be: during high power exposure, after approximately 10 seconds, the lamp extinguishes and requires 2 to 4 minutes to restart. One blower will speed up to compensate for the defective unit or low power. When the unit switches to high power, the additional heat causes one of the lamp thermostats to open. (See also Interlock System for information on the thermostats.)
- To test the blowers, turn the power supply main switch on then off. During the cool-down cycle, place a piece of paper over each intake vent located on the lamp end. The paper should be drawn to the lamp end. If one lamp end does not draw, that blower is suspect.
- To replace the blower in the lamp head, see section 14.9 Opening Lamp Head.

## **Blown Fuse on PC Board**

- If the fuse blows on the printed circuit board, check if the fuse is a 5 amp fuse.
- The printed circuit board drives five or six circuits: the lamp head blowers, shutter motor, power supply blower, and the relays. To find the cause, unplug the unit and replace the fuse; then disconnect the wires to the lamp head on terminals 5 and 6, and disconnect one of the wire nuts connecting the blower in the power supply. The relay coils rarely cause any problem.
- Plug in the unit and turn on the power switch for 10 seconds. If the fuse blows, the problem is either: the power supply blower, the p.c.board or in one of the relay coils. Unplug the unit and reconnect the red wire to the terminal strip. Plug in the unit and turn on, then off. The shutter should now turn. If the fuse blows, the problem is in the shutter motor or wiring to the motor. Unplug the unit and connect the blue wire to the terminal strip. Turn on the unit, then off for the cool-down cycle to test the lamphead blowers. If the fuse blows during this test, the problem could be with either of the two blowers in the lamp head. Normally, when the coil on a blower fails, the coil will become discolored. See section 14.9 Opening Lamp Head. If the fuse has not blown throughout the test, the power supply blower is suspect.

## Lamp Head Signals

### Signals at the Terminal Strip (Cable to the Lamp Head)

A great deal of information about the operation of the lamp may be found at the terminal strip, in the power supply that connects to the lamp head. The terminals are counted number 1 at the end where the cable begins, and wire number 18 is the last wire. Terminal number 1 is closest to the dividing wall in the power supply.

Terminal#	Description
#1	Ground to lamp head
#2	Lamp
#3	Lamp
#4	V~ common
#5	Lamp fans
#6	Shutter motor
#7	Shutter position switch
#8	Not currently used
#9	Shutter position switch
#10	Interlock and thermostat switching
#11	Not currently used
#12	Incoming voltage
#13	Autoformer
#14	Incoming voltage

- #1 The ground terminal is for safety purposes and carries no current.
- #2#3 Lamp terminals 2 and 3 carry the power to the lamp. If the lamp is hot or fails to start, the voltage should be 600 to 950V~. During this time, there are voltage pulses that may damage a sensitive voltmeter. Immediately after the lamp strikes, the voltage will drop as low as 20V~, then rise as the lamp warms to the operating voltage, between 180 and 240V~.
- #4 V~ common terminal is the V~ return for the lamp fans, the shutter motor, and the interlock switch. On 120V~ equipment, this is the V~ common from the power line. This potential is generated on 208/240V~ equipment and may be 60V~ from the line common.
- #5 The voltage applied to the lamp fan varies as cooling is required. The voltage is measured referenced to terminal 4 and terminal 5. This voltage starts at 0V~ during unit warm-up and when the lamp temperature rises it increases. As the lamp reaches temperature, the fans speed



increases to regulate the lamp. At idle, this voltage is typically 45 - 90V~ and depends on the lamp age and ambient temperature. When an exposure at high power is initiated, the lamp voltage rises to the maximum. The voltage remains there after the lamp returns to low power, until the lamp temperature again stabilizes.

- #6 The shutter voltage is present during the rotation of the shutter. The shutter motor runs on 120V~ measured to terminal 4.
- #7 Shutter position DC common (see terminal 9)
- #8 Not presently used
- #9 The shutter position switch reports the position of the shutter to the printed circuit board. This switch is open when the shutter is closed, and closes when the shutter opens. This signal is low voltage DC and can be measured (+) on terminal 9, (-) on terminal 7. The meter will read +12 VDC when the shutter is closed, and 0 VDC when the shutter is opened.
- #10 Interlock and thermostat switching. During normal operation, terminal 10 is shorted to terminal 4 (V~ common). An V~ voltage present would indicate the glass switch or one of the two thermostat switches open.
- #11 Not presently used.
- #12#14 Incoming voltage. To get load voltage, meter between terminals 12 & 14 while power is on. On 208/240V~ equipment set voltage selection switch accordingly, (low=219V~ or below, high=220V~ or above).
- #13 a. Autoformer

### Light Function States

Model	Warm-Up	Idle	Low Exp.	Med Exp.	High Exp.	Cool Down	Trigger
Unit Fans	On / On	On / On	On / On	On / On	On / On	On / On	On / On
Power Relay	On / On	On / On	On / On	On / On	On / On	Off / Off	Off / Off
Shutter	Closed / Off	Closed / Off	Open / Off	Open / Off	Open / Off	Open / Off	* / Off
	Lamp Fans	Off / Off	Var.Slow / On	Slow/Med. / On	Med./Fast / On	Fast / On	Fast / On
Off / Off	High Relay	On / On	Off / Off	Off / Off	Off / Off	On / On	* / *
* / *	Medium Relay	On / On	Off / Off	Off / Off	On / On	On / On	* / *

**Warm-Up** - Occurs after the lamp ignites and ends when the lamp has warmed to operating temperatures. The lamp fans are held off and the unit goes to high power. Due to the technology of the power supply, the units do not draw large amounts of current during warm-up. Due to the restrictive cooling, the lamps warm up rapidly, without surge current. The shutter will not open until the unit reaches temperature.

**Idle** - Between exposures, the lamp is held in idle. During this period, the lamp fans vary in speed to maintain the proper lamp temperature. This allows the unit to consume less power on idle, and provides a wider range of exposure capabilities, since this same low power level is available for exposures. The lower idle saves power, generates less heat, and extends the lamp life.

**Expose** - The units allow exposures at three levels. At high power, the high and medium relays are activated. At medium power, the medium relay is activated.

**Cool-Down** - When the unit is switched off, all fans are turned on to cool the equipment. After the cooling period, the unit disables all of its functions until it is started again.

**Trigger** - If the lamp is turned on before the unit has fully cooled, the fans will run at full power and a trigger pulse is created. This mode will release itself when the lamp strikes. The unit is responding to conditions to provide these functions. It is therefore not possible to confuse the unit. If there is a momentary loss of power, the unit will cool the lamp until it strikes. It is recommended that the unit be shut off and allowed to cool, rather than turning off the power supplied to the unit.

## Printed Circuit Board Layout

This is a description of the signals and voltages present on the pins of the printed circuit board.

64MV407V03 Control Board layout. Used on all **BUT** 8kW light sources

64MV407V24 Control Board layout. Used on all 8kW light sources

**Note:** Graphic of the new style p.c.board is shown. Relay style p.c.board has the same connector hookups and pin outs, however the LEDs are on the component side of the p.c.board not on the solder side as on the new style. The old style board is replaced by the new style and is interchangeable.

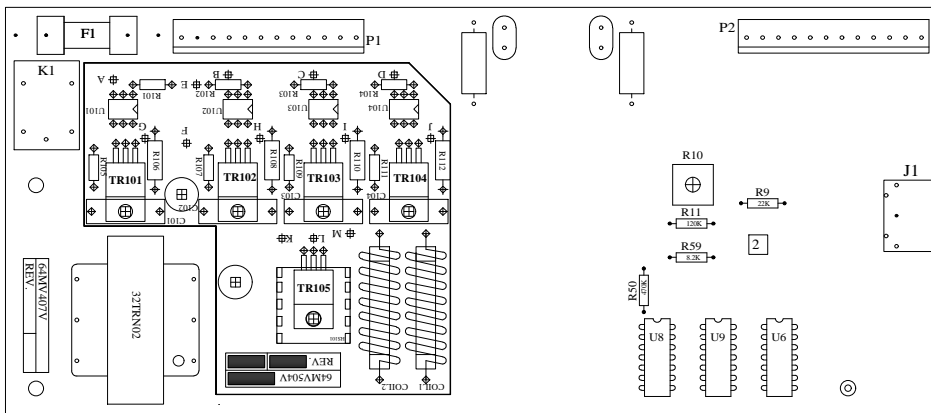

Front View of Control Board

Triacs & Relay	
K1	Unit Power
TR101	Shutter Motor
TR102	High Relay
TR103	Medium Relay
TR104	Main Contactor
TR105	Lamp head fans

P1 Power Connector			
1	AC Hot	7	Unit Fan
2	AC Common	8	Power Relay
3	Lamp Fans	9	Not Connected
4	Shutter Motor	10	Aux Terminal
5	High Relay	11	DC Common
6	Medium Relay	12	Position

P2 Switch Connector			
1	AC Hot	7	High Switch
2	AC Common	8	Low/Med Switch
3	Not Connected	9	Manual Expose
4	Aux Terminal	10	Interlock
5	DC Com/Ground	11	Not Connected
6	Power Switch	12	+12 VDC

LED's	
D18	Lamp head fans
D13	Power Supply Fan
D17	Shutter Motor
D15	High Relay
D16	Medium Relay
D14	Power Relay

Check Idle Voltage on Board or on Terminal Strip Lugs #2 and #3

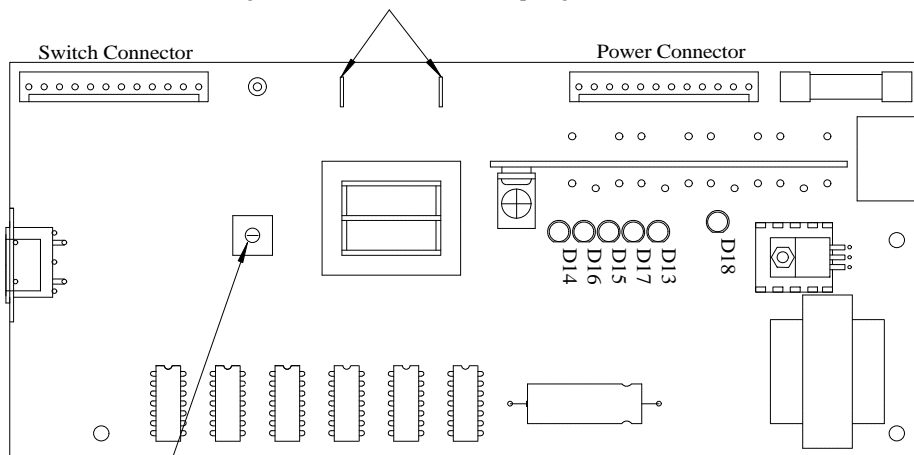

Idle Voltage Adjustment

Back View of Control Board

## Signal Description

### Power Connector

P1)	V~ Hot: Supply to board approximately 125V~.
P2)	V~ Common: Common to board is the common also for relays, shutter fans, and the internal lamp head interlock. (This may not be at ground potential and should be measured with caution).
P3)	Lamp Fans: V~ proportional drive output for the blowers in the lamp head.
P4)	Shutter: V~ output to drive the shutter motor.
P5)	High: V~ Output to drive the high relay, which engages the high power capacitor bank during warm-up and high power exposures.
P6)	Medium: V~ Output to drive the medium relay which engages the medium capacitor bank during warm-up and both high and medium level exposures.
P7)	Unit Fan: V~ Output to drive the power supply blower or fans.
P8)	Power Relay: V~ Output to drive the main relay. This provides power to the lamp circuit.
P9)	Not currently used.
P10)	Aux: Terminal connects to the signal connector for accessories (Not used in most equipment).
P11)	DC Common: Circuit common for low voltage signals from the lamp (this may not be the same potential as V~ Common connection and should never be interchanged).
P12)	Position: Shutter switch active signal from the lamp head - Low voltage when the shutter is open and 12VDC when closed.

### Switch Connection

S1)	V~ Hot: Output, V~ supply for internal accessories.
S2)	V~ Common: Output, V~ common for internal Accessories.
S3)	Not currently used.
S4)	Aux: Terminal connects to the power connector for accessories (Not used in most equipment).
S5)	DC common: DC circuit common for switches (Not the same as V~ Common).
S6)	Power Switch: Switch to turn on power. Low (0V) for power on. The power can also be turned on by the integrator through the outlet. (Only a signal ! Power is always present on the PC Board).

*Continued on next page*

S7)	High Switch: Switch to select high power level. Low (0V) for high.
S8)	Low/Med Switch: Switch to select power level when high switch is off. Low (0V) for medium power, High (12VDC) for low power.
S9)	Manual Switch: Manual expose switch. Low (0V) to cause exposure.
S10)	Interlock: External interlock outlet. Line must be connected to DC common to allow an exposure. (Outlet is normally shorted when plug in not inserted).
S11)	Not currently used.
S12)	+12V: Output for internal accessories (Not used in most equipment).

### **DIN Connection**

D1)	Expose: High expose when connected to a compatible integrator. High / Medium / Low expose depending on the unit switches when connected to an older style integrator or other manufacturer's equipment.
D2)	DC Common: Common for all signals.
D3)	Low Exp: Low expose input.
D4)	Power: Signal from integrator to turn on the power.
D5)	Medium Exp: Medium expose input.

### **LEDs**

The LEDs are an indicator of an acting command that you are asking the control board to do. For a list of which commands activate which LEDs, look at the chart above, labeled LED indicators. The LEDs light when they detect a ground or negative going pulse.

# Circuit Diagram (64MV407 60Hz)

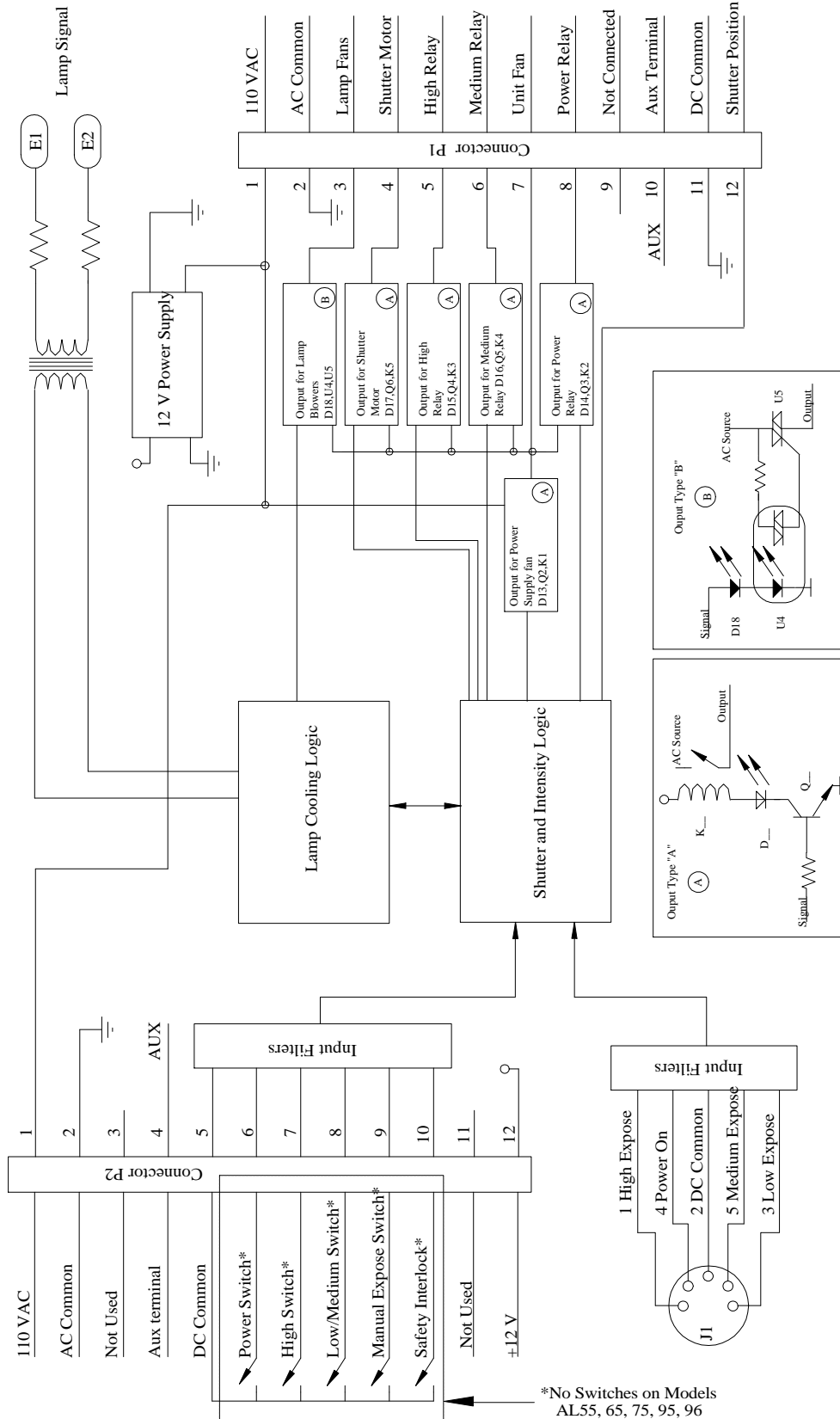

# Lamphed for all Lights

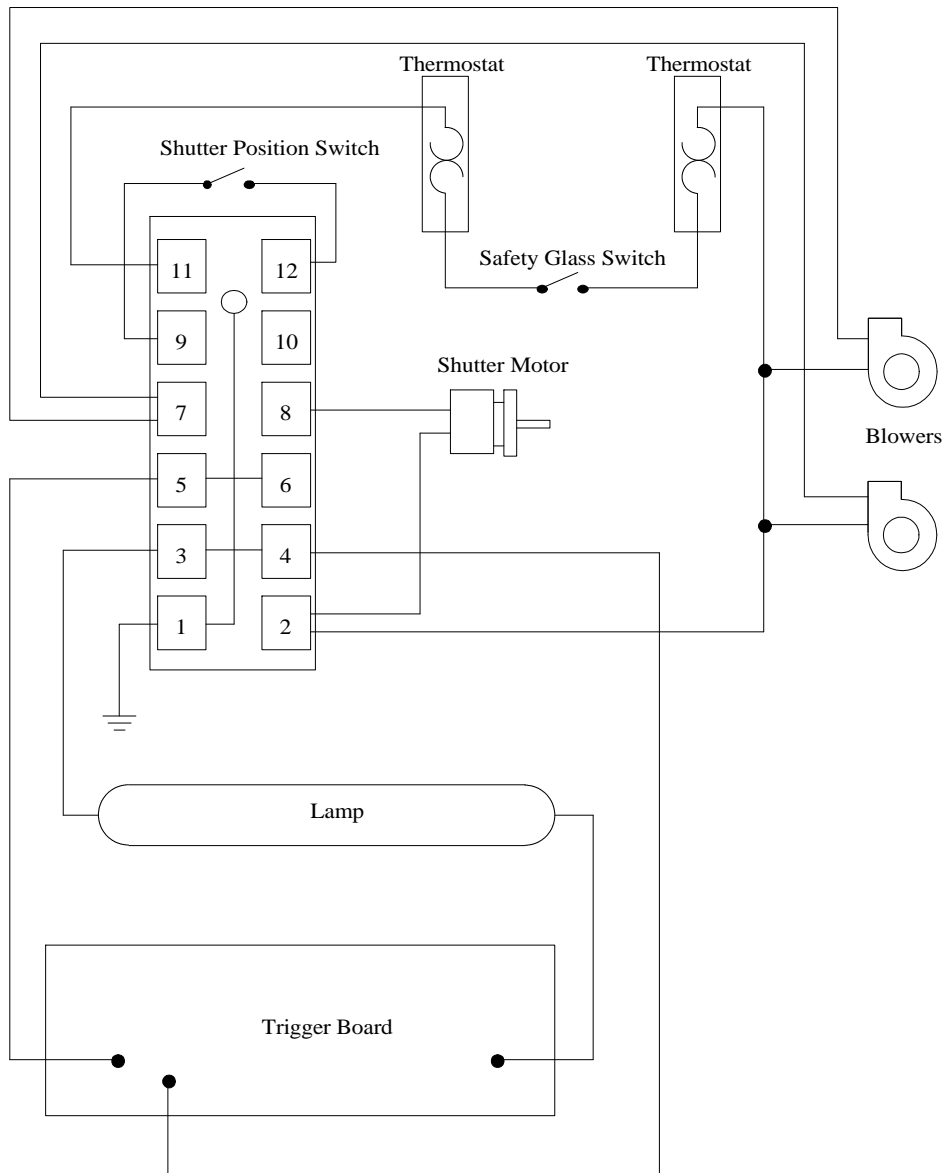

# AL 54 Power Supply 60Hz

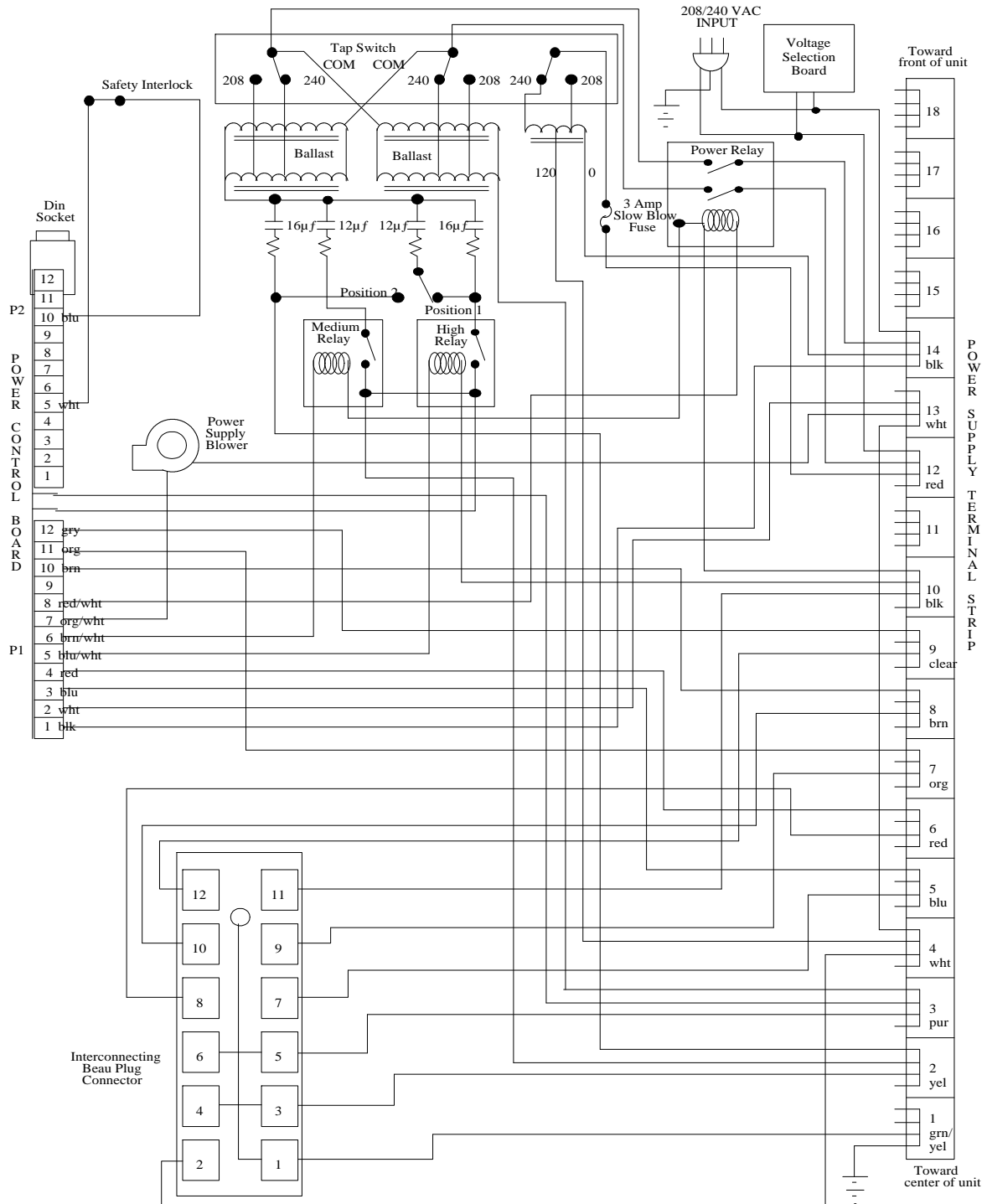



# AL 54-480 Power Supply 60Hz

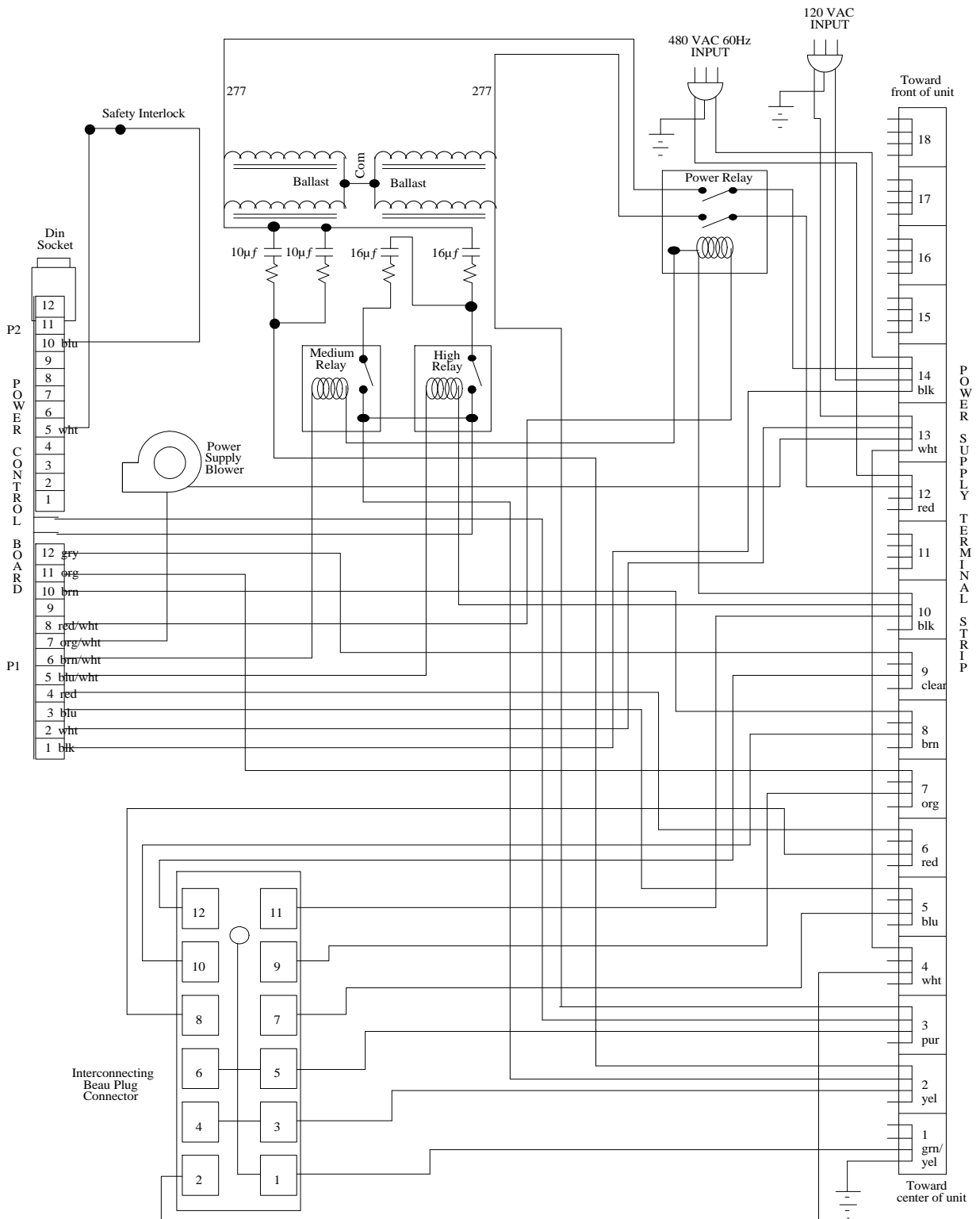

# AL 64 Power Supply 50Hz

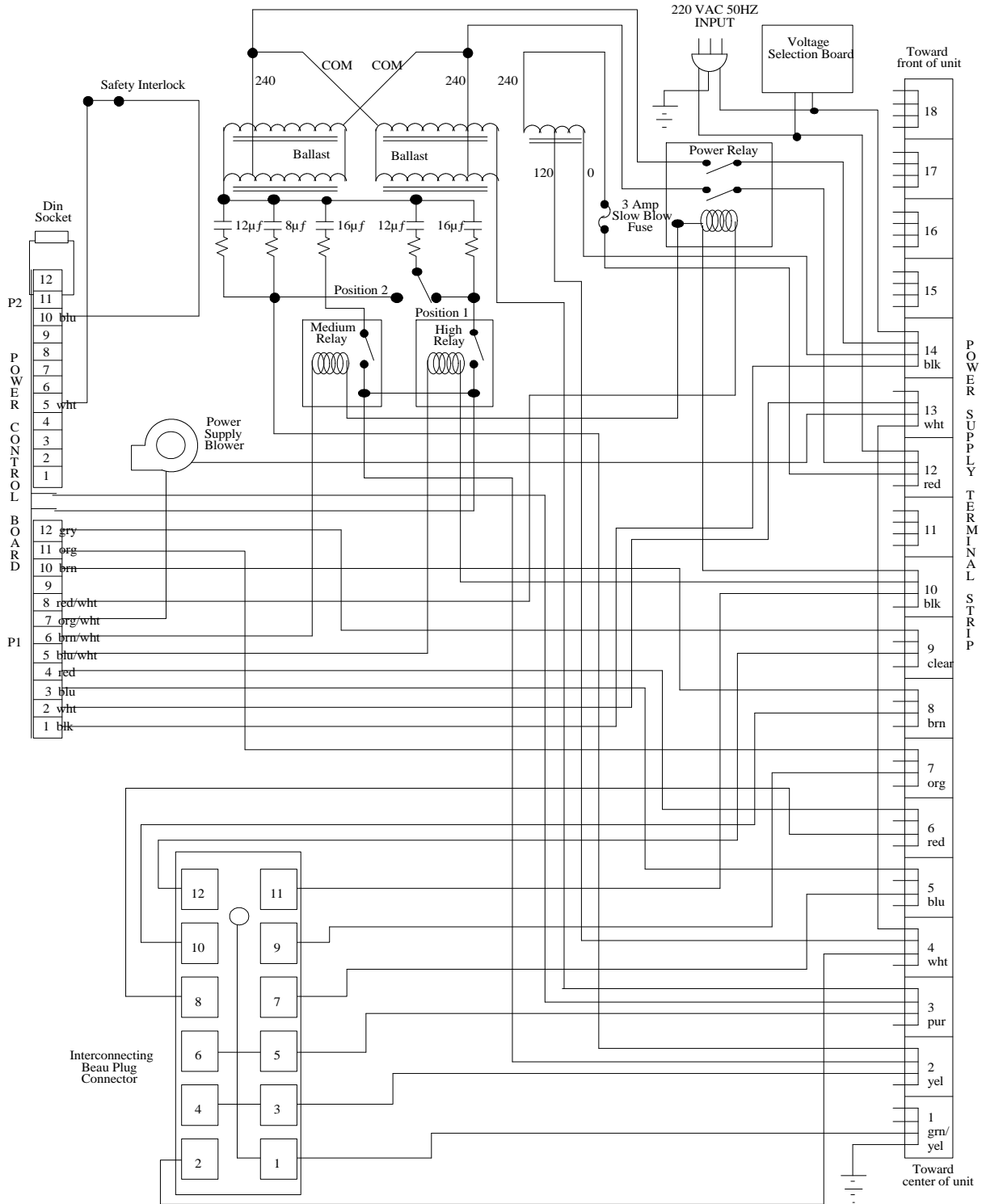

# AL 84 Power Supply 60Hz

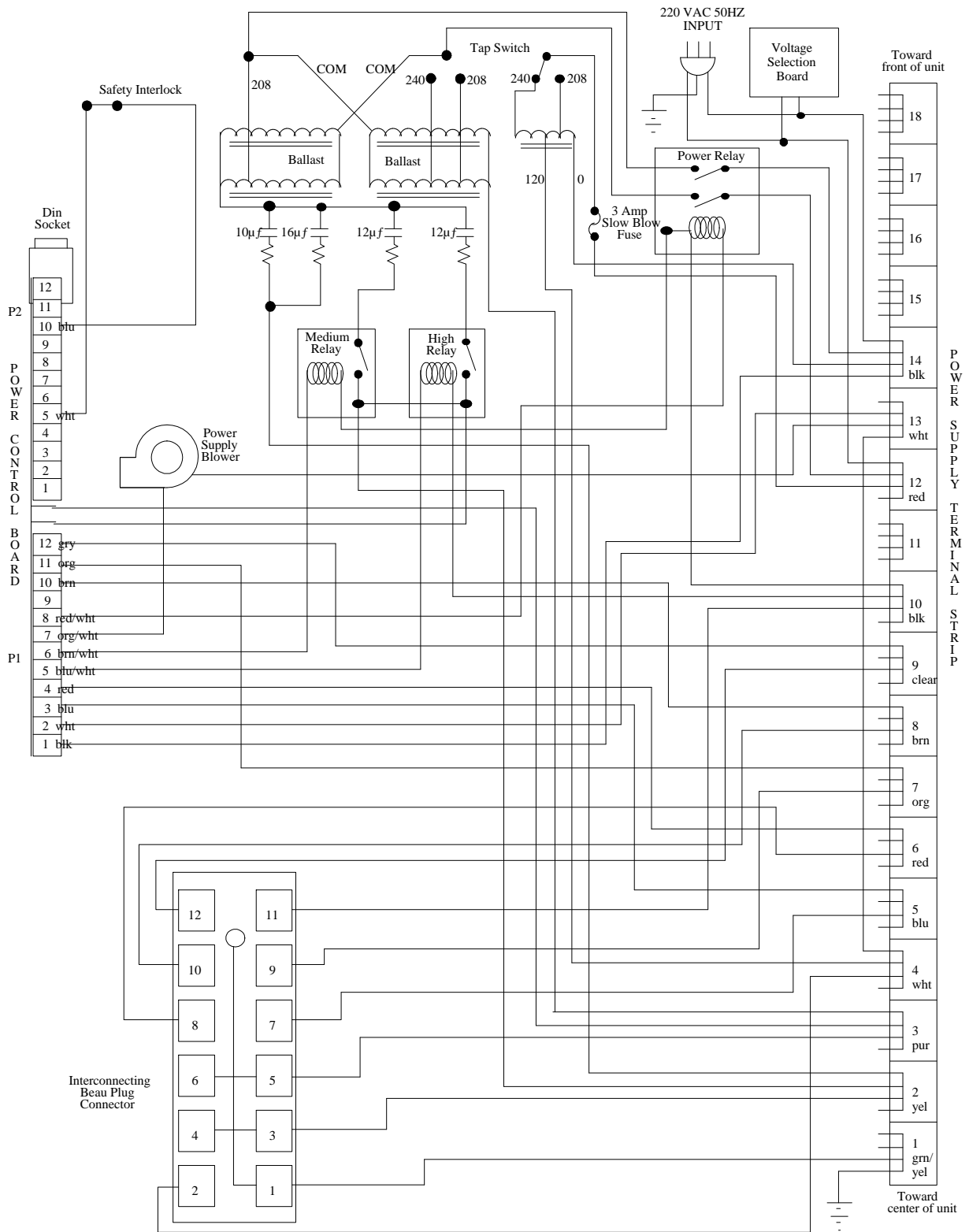

# AL 84-480 Power Supply 60Hz

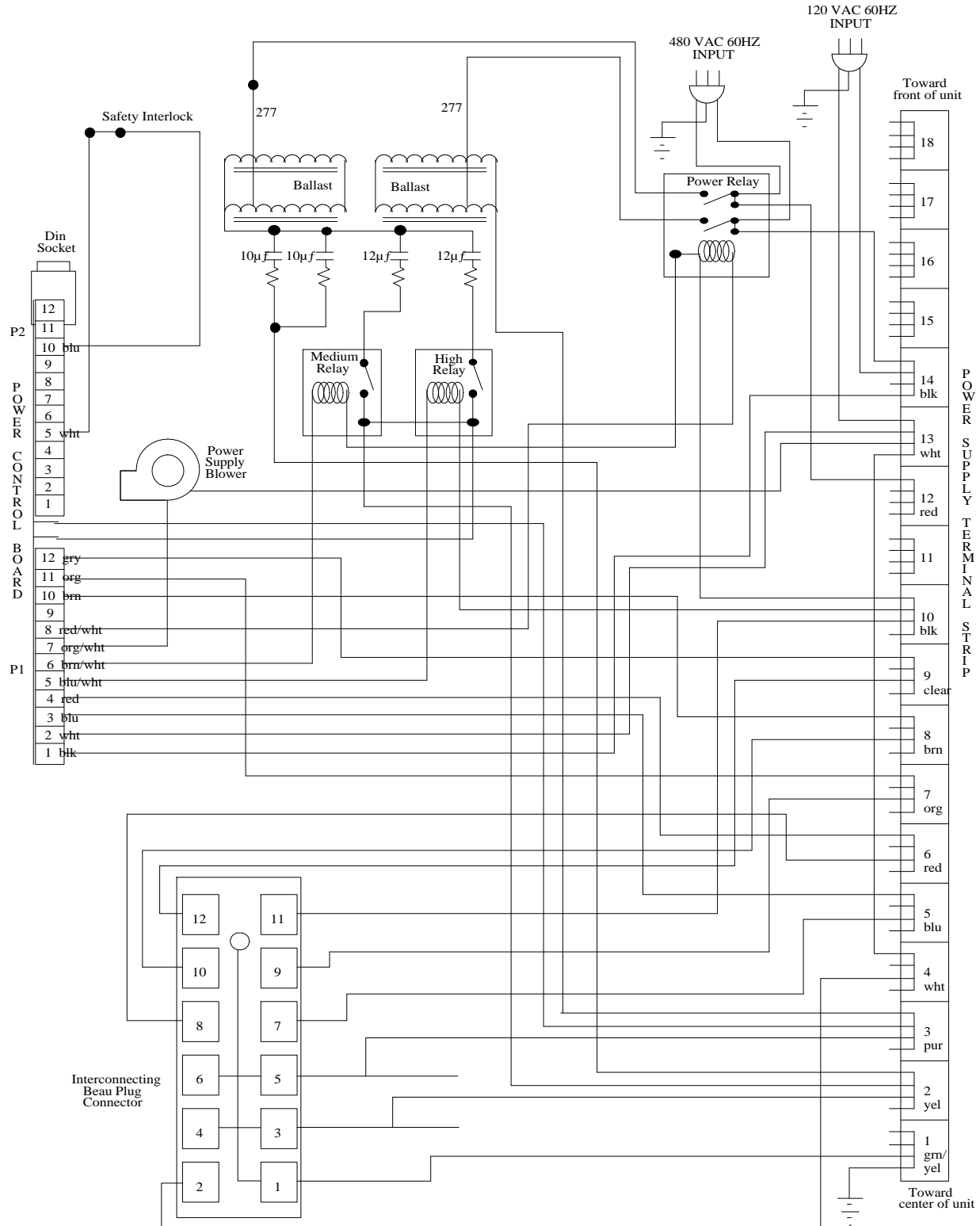

# AL 94 Power Supply 50Hz

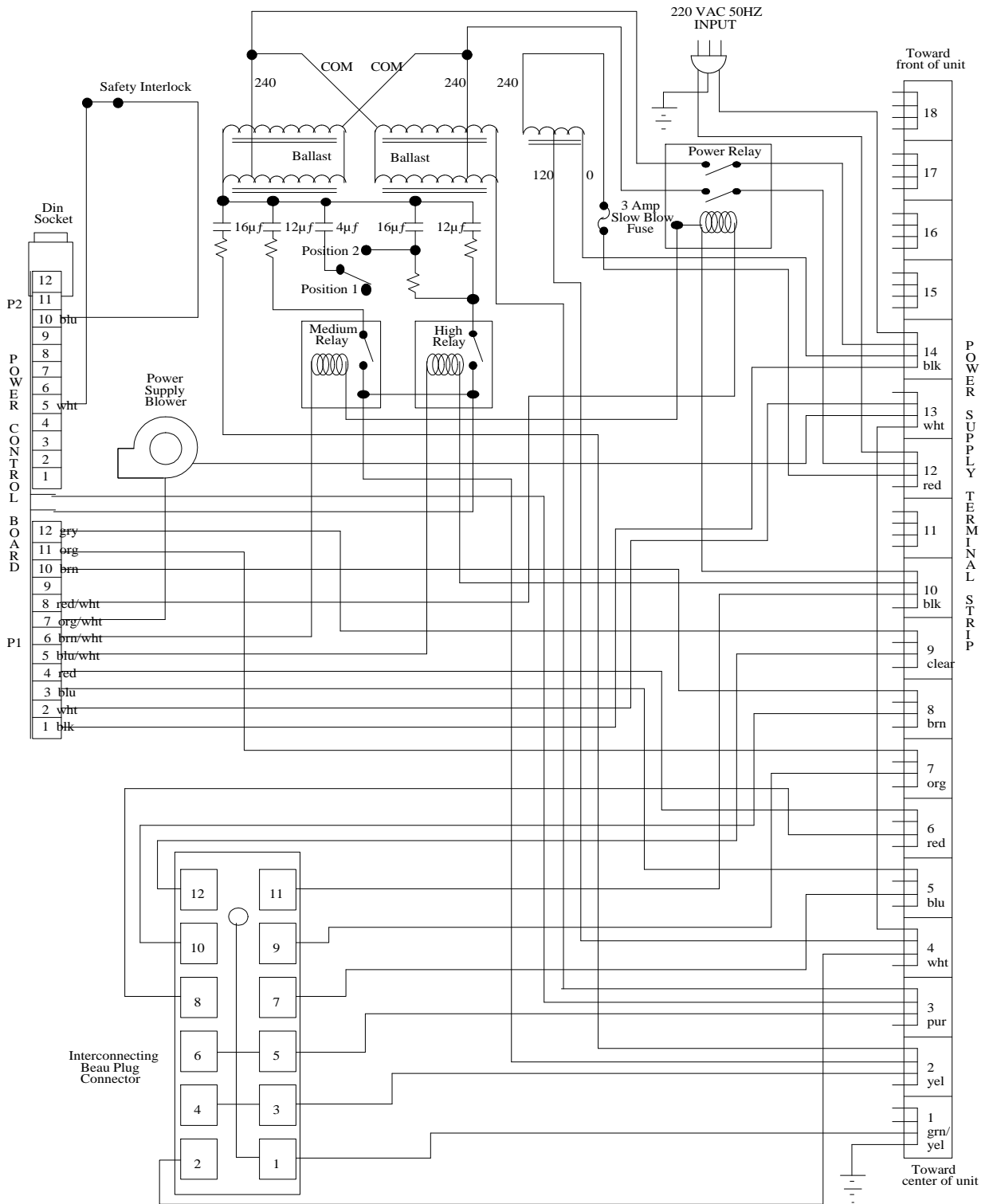

# Interconnect Cable

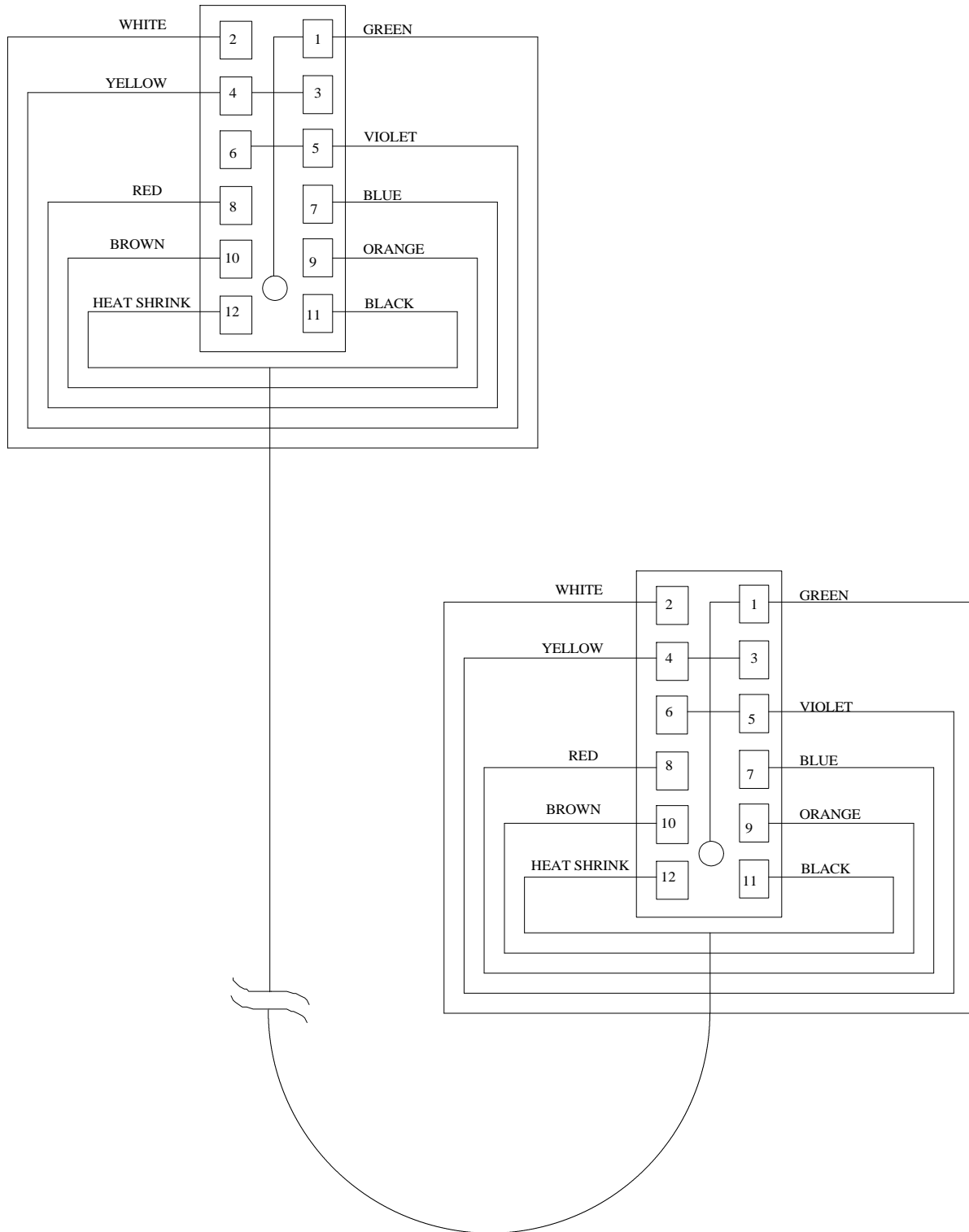

## 14. Printing Light Check List

---

### Check List for Printing Light Troubleshooting and Service



**CAUTION** In order for this check list to be effective it must be followed step by step.

- 1) Disconnect the integrator/timer from the power supply.  
This will make sure that a faulty integrator or cable is not responsible for the malfunction and also eliminate a bad DIN socket on the p.c.board.
- 2) Check the tap switch (208/240V~ power supplies only. If the top LED is lit, make sure the switch is in the UP position, and if the bottom LED is lit, make sure the switch is in the DOWN position (see Printing Light Installation Manual). Improper setting will most likely cause blower, capacitor, and/or PC board failure and will prematurely age the lamp.  
The LEDs next to the switch are not controlled by the switch, the LEDs tell you where to put the switch.



**CAUTION** You **MUST NOT** flip this switch with the power supply turned on! You will arc the contacts inside and this will damage the switch.

- If the tap switch is set for 240V~ and you have 208V~ coming in, the light source is going to draw excess amperage (as voltage goes down amperage draw has to go up). If when you open the power supply you notice right off burnt wires or connectors, one of the most likely causes is the tap switch in the wrong position. This condition usually take months and sometimes years (depending upon the degree of voltage discrepancy) to show up. When the burnt wire is on the tap switch itself or on the bottom side of the power relay it is very difficult to see the burnt wires without some disassembly of the power supply.
- If the tap switch is set for 208V~ and you have 240V~ coming in, the p.c.board and the blowers are usually the two items to get damaged. Over voltage to the blowers will burn them out and are usually the first to component damaged, the p.c.board will also be damaged under extended usage in an over voltage condition.
- If the voltage fluctuates there is a line that you can not cross 219V~ 220V~ the voltage must always stay 220V~ or above or always stay 219V~ or below.

If the switch itself is bad with no external signs of burning make sure that the user is not flipping the switch with the power supply on. Flipping the switch with the light source turned on will cause damage to the switch that may take time to show up.

- 3) Check the safety glass for proper installation. The long dimension of the glass goes parallel with the long dimension of the lamphead. Improper installation can cause the glass to shatter and/or an 'open' in the safety interlock circuit.



- You must be able to reach up, place your fingers against the safety glass and there must be play front to back and side to side. Otherwise the glass does not have room for expansion and will more than likely shatter under use.

**CAUTION** **NEVER** operate the light source without the safety glass in place.

- 4) Check the beau plug at the lamphead. Make sure it is pushed in all the way. The most likely problem caused by a loose beau plug is an erratic shutter operation or an open safety interlock circuit.

Just push in on the beau plug while rocking it up and down to make sure it is in all the way.

- 5) Check the lamphead interlock circuit. Remove or lower the safety glass. Turn the power supply on. Check for 120V~ from terminal 4 to terminal 10; when the glass is reinstalled, the voltage should go low. (See Interlock System for operation.)

With the interlock open what should happen is the shutter should close and the power supply blower should come on, that's all. After you remove the glass and you turn on the power supply, if the light source comes on turn power off immediately and determine what is shorting out and bypassing the safety interlock circuit. If this does happen it is possible that the safety interlock circuit is shorting to ground. On older light sources this condition would burn up the autoformer. On newer light sources this condition will blow the 3A slow blow fuse on the dividing wall below the wiring harness.

- 6) Check input voltage with the power off at terminals 12 & 14. Then with power on, intensity level on high, and manual expose set on, check the voltage again. If the voltage drops more than 6 V~, the incoming power is most likely a problem.

You can do checks 6 and 7 at the same time. Write down the voltage that you get before turning power on and after turning power on but before the light source completes the warm up cycle. This is maximum amperage draw so the voltage will show maximum drop.

If the voltage in check 6 drops more than 6V~ the incoming power is a problem and it can not be corrected in the power supply (there is nothing you can do in the power supply to correct bad voltage from the wall).

- 7) Check input voltage to the PC board with the power off at pins 1 & 2 (see p.c.board layout for pin location). Then with power on, intensity level on high, and manual expose set on, check the voltage again. If the voltage drops more than 6 V~, the autoformer is most likely a problem.
- If and only if the voltage on 12 and 14 in step 6 is good can you say that the autoformer is definitely bad, if the voltage on 12 and 14 in step 6 is bad you can not get a correct reading for step 7.



8) Check capacitors and relay circuit by:

The capacitors and relays are checked by watching the voltage changes that take place at the different intensity levels. If a capacitor is not in the circuit the voltage readings on input and output will be the same. If the capacitor is pulled into the circuit the input and output voltages will be hundreds of volts apart. Now the tricky part, if a capacitor is pulled into the circuit the way it is supposed to be then we need to look at the voltage itself to see if we see an increase in the overall voltage to make sure that the capacitor is adding voltage to the circuit. If the capacitor is pulled into the circuit when it is supposed to be but the overall voltage does not increase then the capacitor is defective.

9) Check voltage from terminal 3 to the capacitor input (orange wire on top of the capacitors). The voltage should be 500+ V~. If voltage is lower, check the power path to the tap switch and ballasts. 500+V~ is typical for 5kW light sources and 700+ V~ for the 6kW and 8kW light sources. If the voltage on a 208/240V~ is low, then not all the ballasts are being powered properly. This is usually caused by a bad tap switch or a burnt connector at the tap switch, however any of the wiring between ballast and tap switch is suspect. If the voltage is zero then a burnt wire at the power relay or a bad power relay is most likely the problem. There is a possibility that if there is zero V~ that you might have a grounded safety interlock circuit.

- At idle, check voltage from terminal 3 to the capacitor outputs (yellow, brown, and blue wires on top of the capacitors).

On the following charts find the Wattage of the unit you are working on and then for the lamp installed into the unit, these are the general voltages you should read. These voltages are a ball park figure depending upon several factors and the actual voltage is not as important as to whether or not the voltages change on the capacitors according to intensity level. For instance on a 5kW light with an L1250 lamp at low intensity one capacitor will be about 200V~ and three capacitors will be over 500V~. Now when you go to medium intensity you should see two capacitors at about 230V~ and two capacitors at over 500V~. **NOTE** the number of capacitors at the lower voltage (i.e. in the circuit) and the voltage increase from the previous intensity 200V~ at low and 230V~ at medium.

- At low power, manual expose on, check voltage from terminal 3 to the capacitor outputs (yellow, brown, and blue wires on top of the capacitors).
- At medium power, manual expose on, check voltage from terminal 3 to the capacitor outputs (yellow, brown, and blue wires on top of the capacitors).
- At high power, manual expose on, check voltage from terminal 3 to the capacitor outputs (yellow, brown, and blue wires on top of the capacitors).
- SEE CHART FOR PROPER VOLTAGE READINGS (ALL VOLTAGES ARE READ TO TERMINAL 3).

5kW with L1250 LAMP						
		ORANGE	YELLOW	BROWN	BLUE #1	BLUE #2
a.	IDLE/LOW	500+	200	500+	500+	500+
b.	MEDIUM	500+	225	225	500+	500+
c.	HIGH	500+	270	270	270	270

5kW with L1252 or L1261 LAMP						
		ORANGE	YELLOW	BROWN	BLUE #1	BLUE #2
a.	IDLE/LOW	500+	200	500+	500+	500+
b.	MEDIUM	500+	230	230	500+	500+
c.	HIGH	500+	270	270	270	270

8kW with L1280 LAMP						
		ORANGE	YELLOW	BROWN	BLUE #1	BLUE #2
a.	IDLE	700+	360	700+	700+	700+
b.	LOW	700+	360	700+	700+	700+
c.	MEDIUM	700+	390	390	700+	700+
d.	HIGH	700+	425	425	425	425

8kW with L1281 LAMP						
		ORANGE	YELLOW	BROWN	BLUE #1	BLUE #2
a.	IDLE	700+	395	700+	700+	700+
b.	LOW	700+	395	700+	700+	700+
c.	MEDIUM	700+	425	425	700+	700+
d.	HIGH	700+	485	485	485	485

8kW with L 1282 LAMP						
		ORANGE	YELLOW	BROWN	BLUE #1	BLUE #2
a.	IDLE	700+	395	700+	700+	700+
b.	LOW	700+	395	700+	700+	700+
c.	MEDIUM	700+	430	430	700+	700+
d.	HIGH	700+	510	510	510	510

‡ The voltage readings described in the following are typical of 5kW light sources see voltage chart to find high and low values for others.

10) If a reading remains high (500V~ or more see note ‡) and it should be low (less than 300V~ see note ‡), the capacitor is not being pulled into the circuit. Check the respective relay, resistor, and wiring for an open.

11) If a reading remains low (less than 300V~ see note ‡) and it should be high (500V~ or more see note ‡), the capacitor is locked into the circuit. Check the respective relay, wiring, and PC board for a short.

12) If the readings show voltage changes from high to low and from low to high, but the overall low reading does not increase from the previous power level, then the capacitor being pulled into the circuit has failed.

13) Check the blowers using a piece of paper held up to the intakes at each of the lamphead during a cool-down cycle. The paper should get held up to each intake, if it doesn't, the blower is bad.

Blowers speed can not be checked until this point because all previous checks affect the operation and can make them appear to be operating incorrectly. Also check blower voltage at terminals 4 & 5 for most lights this voltage should be a MINIMUM of 45V~ some lights this voltage will be higher depending on lamp used and lamp condition.

14) Check for cooling obstructions on intakes and exhausts. If any are found, remove them.

15) Check lamp idle voltage at terminals 2 & 3. This voltage should match the voltage chart above, if not, YOU MUST install a new lamp and recheck (see Idle Setting if adjustment is necessary).



**CAUTION** DO NOT ADJUST idle voltage with a used lamp.

Lamp voltage can be effected by all the checks in the check list to this point. So if this check list is used properly (followed step by step) if at this point the lamp voltage is out of specification it can now be adjusted if the lamp is less than two weeks old **AND "not or"** has no sign of deformation otherwise a new lamp must be installed before adjusting. Adjusting lamp idle voltage without first checking other causes of the lamp voltage deviation can damage the equipment.

16) If used, check the power supply safety interlock jack next to the power supply power on/off switch. A failure in this circuit will not allow the unit to do an exposure, the only time the shutter will rotate if this circuit is open, is when the power is turned on or off.

If you suspect this circuit is faulty, turn the manual expose switch on, then short the blue and white wires on the jack together with a screwdriver (make sure you do not short to ground) and see if the shutter opens, if it opens the circuit is at fault.

17) Check for smooth shutter rotation. If the shutter rotates smoothly, skip to step 20, otherwise continue.

18) If the shutter does not rotate smoothly, it may not stop in the correct position and the bearings must be greased.

- 19) If the shutter fails to rotate at any time, then check the following:
- 20) When the shutter is supposed to be moving. Check for 120V~ between terminals 4 & 6. If there is voltage, go to the lamphead and check for voltage at the shutter motor then skip to step 22.
- 21) If there is no voltage between terminals 4 & 6, check the PC board output for voltage at pins 2 & 4 (see PC Board Layout for pin location).
- 22) Check to make sure the shutter stops immediately in the correct position.
- 23) If the shutter stops immediately, but in the wrong position, check the shutter position switch.
- 24) If the shutter coasts to a stop in the wrong position, check the shutter brake.
- 25) If you run into a situation where you are not getting voltage at the terminal strip, relay, blower, etc. make sure you go to the PC board itself and Double check the PC board outputs before replacing it.
- 26) Before you reassemble everything it is a real good idea to: Check the manual operations of the light source. Just to make sure everything is back together.
- 27) Reconnect all wires to the integrator and then: Check the remote operations of the light source from the integrator.

# 15. Fault Trees

## No Strike Fault Tree

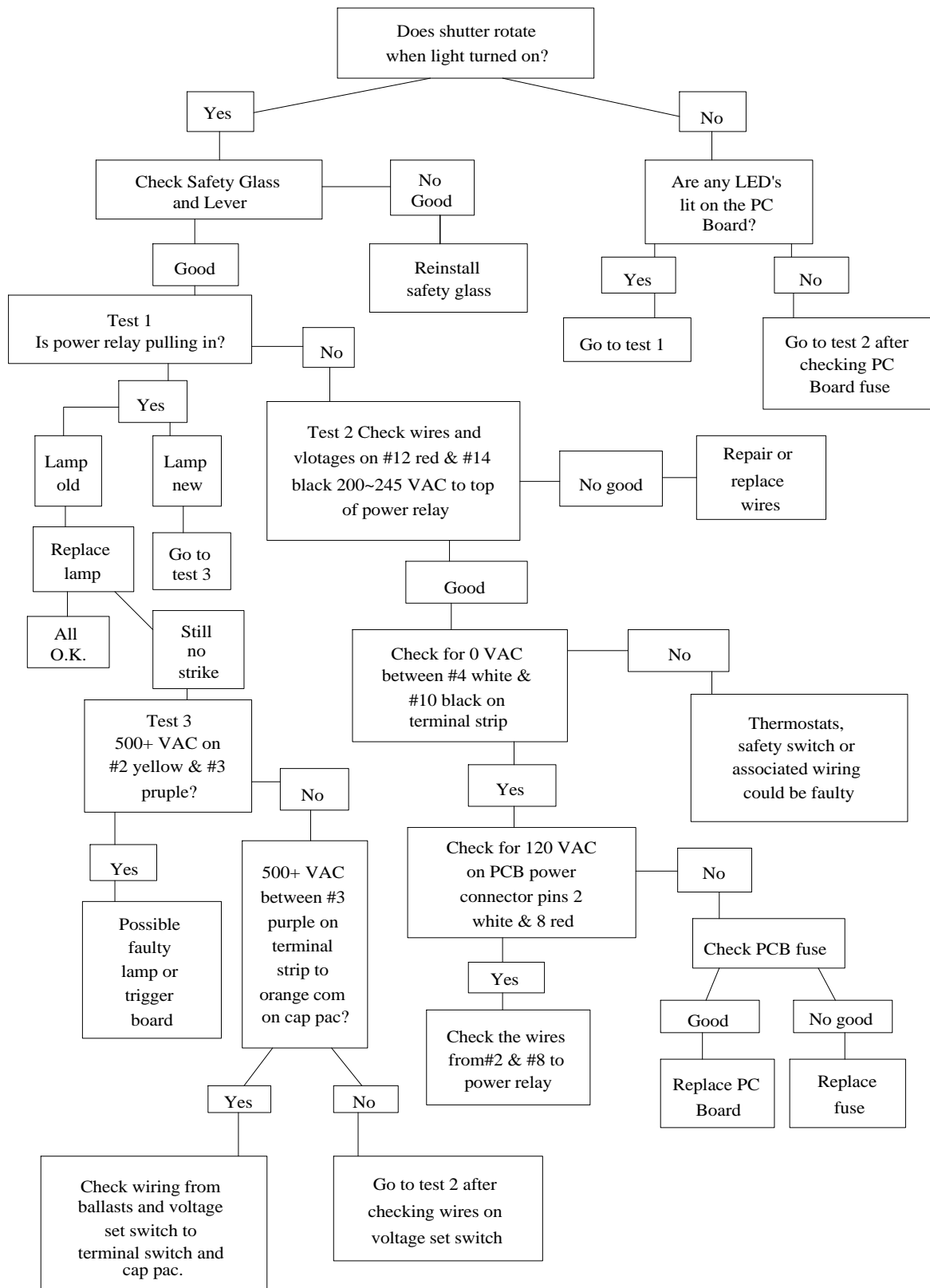

## Shutter Rotation Fault Tree

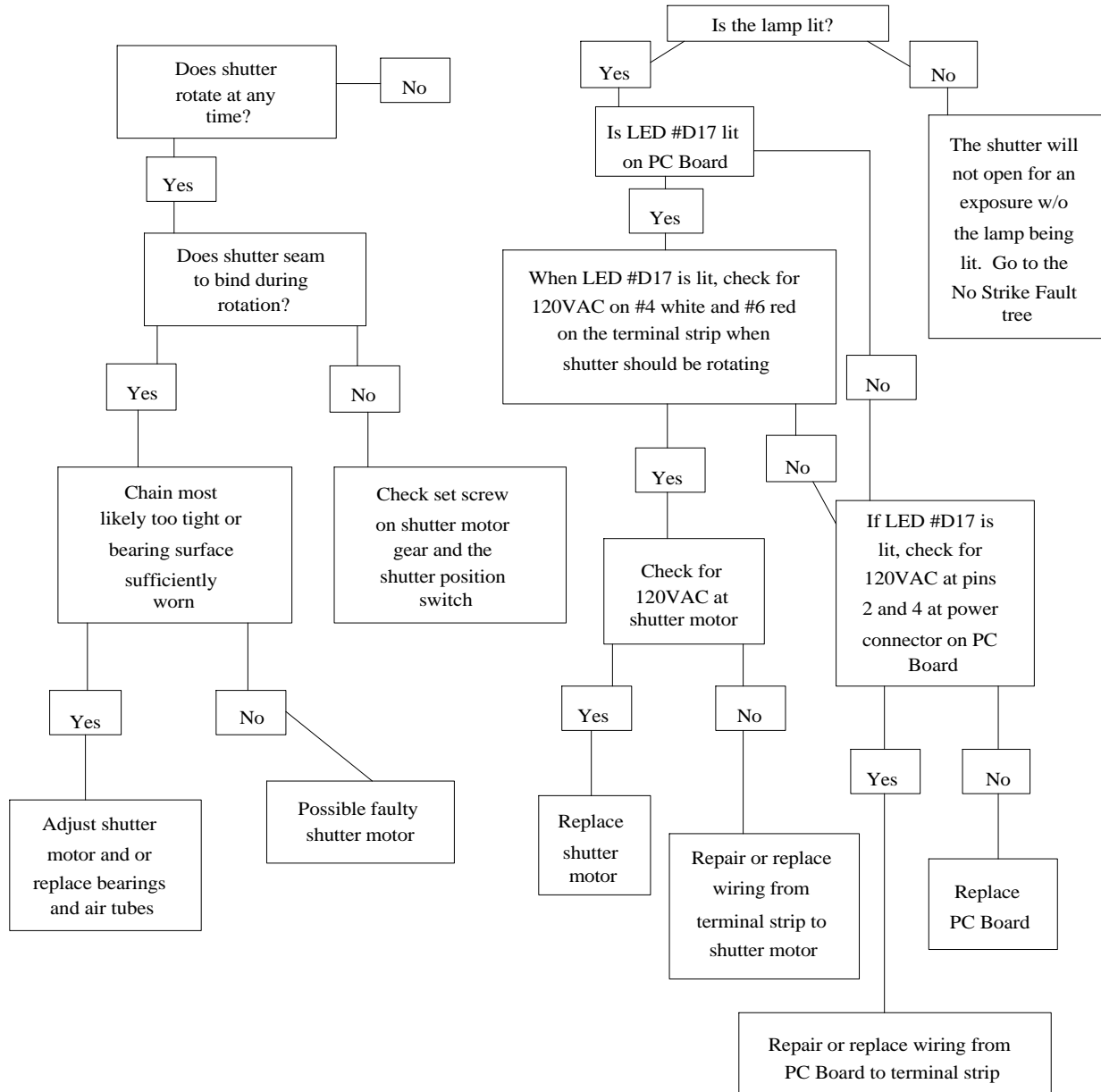

Front View of Control Board

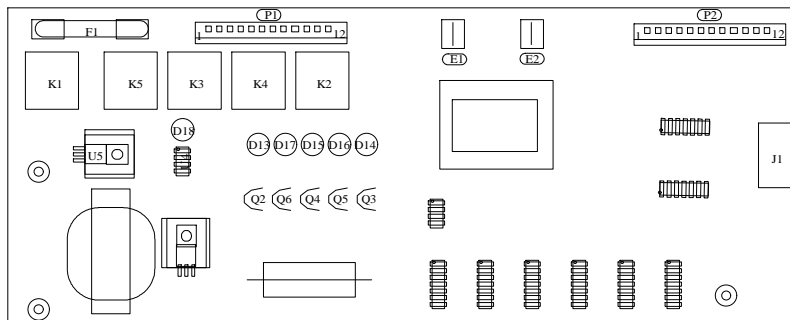

LED's	
D18	Lamp Head Fans
D13	Power Supply Fan
D17	Shutter Motor
D15	High Relay
D16	Medium Relay
D14	Power Relay

## 16. Parts List

Part Number	Description	Qty. per unit
62AP30C	Assy Kit Base Expo AP30	1 EA
11D1648A02	Flangeplate, HF1	2 EA
11D3994A07	External Reflector, AP30	4 EA
15D3830A00	Overlay, control panel	1 EA
32TRC05	Transformer (480V~ units only)	1 EA
39ACD02	Air Conditioner 8K BTU	1 EA
43CLM08	4" Hose Clamp	4 EA
43SPR31	Gas spring	4 EA
49DCT04	Ducting, Alum 4" diam.	2 EA
55SW45-GO	Button, white "GO"	1 EA
55SW45-STOP	Button, white "STOP"	1 EA
56TMP01	Temperature Control	1 EA
<b>62ATA</b>	AccuPrint Tray Assembly	2 EA
11D1726A17	Frame, glass	1 EA
11D2392A62	Catch - Latch Handle	1 EA
11D2422A62	Top, Hinge, Glass Tray	2 EA
41-10WLS	NSI #10 washer,split lock	4 EA
41-12PPMS.50	10-32 X 1/2 PPMS Zinc	4 EA
41B12NKP	#10 Kep Nut	4 EA
41B12PF0.50	NSI 10-32x1/2 Phil Flt MS	4 EA
44GKT07	Seal "Solid D"	2.83 EA
44HDL03	Handle	2 EA
81TAP06	Tape, 1/8" Thk 1/4 W	7.670 FT
81TAP07	Tape,OV24 1/8" x 1" x 50	12 FT
<b>62D1759A00</b>	Glass, Seal Assy Grade B	2 EA
12D1728A62	Intake Port AP 30D	2 EA
12D1738A71	Vacuum Block	2 EA
13D2213E99	Strip, front/rear-32.70"L	2 EA
13D2213F99	Strip,front/rea-31.34"Lg	2 EA
13D2214E99	Strip,RH/LH Side 27.75"Lg	2 EA
13D2214F99	Strip,RH/LH Side-26.38"Lg	2 EA
13D3006B00	Strip,corner(ABS)-.50"Lg	2 EA
18D1734B00	Glass	1 EA
44ADT03	Adapter, Hose	2 EA
44GKT13	Seal, Wave Shape	22 FT

Part Number	Description	Qty. per unit
44ORNG02	"O" Ring 11/16x9/16x1/16"	4 EA
49DCT24	Tubing, 5/16 I.D.x1/2 O.D	2 FT
81TAP12	Tape, Teflon Sealant 1/2"	1 RL
81TAP17	Transfer Tape,3/4 X 18	1 RL
82ADH11	Adhesive, rubber gasket	1 EA
<b>62D2429A00</b>	Assy, AP 30 Nose - Integ	1 EA
11D1791A02	Bracket, Nose Support	2 EA
11D1939A62	C-Bracket, Filter Holder	2 EA
11D1939B62	C-Bracket, Filter Holder	2 EA
11D2426A17	Divider, nose AP30 Left	1 EA
11D2426B17	Divider,nose AP30 Right	1 EA
11D2427A08	Air Director No.1, Nose	1 EA
11D2433A08	Air Director No. 2 - Nose	1 EA
11D2438A08	Air Director No 3 - Nose	1 EA
11D3255A07	Reflector,Work Lt.2 Lamp	1 EA
16D2196A00	Harness, SW, Operator OV	1 EA
16D2412A00	Harness, Emergency Switch	1 EA
16D3249A00	Harness	1 EA
18D2430A00	Bezel, Worklight, 3 Lamp	1 EA
19D1942A99	Filter, Top AP30	2 EA
26CF4-15-4	Resistor,15Kohm,2W,5%	1 EA
32TRC08	Autoformer 208/225/240 V~	1 EA
39BLO11	Blower	2 EA
39CLF02-C	Coated lamp yellow w/fix	2 EA
43FIT13	Reducer, Tube 3/8 to 1/4	2 EA
43FIT14	Connector, 1/4 Tube	2 EA
44PAD03	NSI Tie wrap adh. mnt. ba	3 EA
44TIE02	NSI Cable Tie 4" #18 Max	3 EA
48TRM02	Trim-Lok	FT
49DCT27	Tubing, Nylon 1/4"OD - .1	FT
49VAG02	Vacuum Gauge,0-30"	2 EA
51SI18E	Spade, Ins. 22-18Ga #8	4 EA
52TS05	5 Position Terminal Strip	1 EA
54JMP03	Kulka Jumpers 602J	2 EA
55SW01	Switch, CW	2 EA
55SW45-5	Barrier	4 EA
55SW45	Switch, Nose * AP30/33	2 EA
55SW53	Pushbutton, Emergency Sw	1 EA



Part Number	Description	Qty. per unit
64MI441E-4236	Inegrator pcb master	1 EA
64MI441E-4239	Inegrator pcb remote	1 EA
64PCB-DIS01	Assy, PCB, System, Disply	1 EA
16D2656A00	Cable, 15P, Dip to DB 15	1 EA
64MI477V00	Quick Mem Key Bd AP30	1 EA
64MI478V00	Assembly, Key Bd AP30	1 EA
81TAP12	Tape, Teflon Sealant 1/2"	1 RL
<b>62D3553A00</b>	Assy,Ctrl Bx-5K 208/240V~ 60Hz	1 EA
16D3208A00	Harness, Cntrl Bx -GTools	1 EA
16D3455A00	Harness , CT Box - Closed	1 EA
16D3878A00	Harness, cntrl bx suppl	1 EA
31MSC02	Motor, speed control	1 EA
32PSF01	Power Supply, Open Frame, 1	1 EA
32TRC01	Autoformer 208-240V~	1 EA
33RLY20	Relay, 12VDC, Chassis	1 EA
44CPG08	Plug,plastic,black 1.5"	3 EA
44RUB03	Grommet,Continuous .06	FT
52FUH04	Fuse Holder, 3AG/3AB	4 EA
52FUH07	Fuse Block- 13/32 x 1.5 4	1 EA
52FUH08	Fuseholder, 3AG, .25 Tab	2 EA
52RCP15	Receptacle, 250V/30A	2 EA
52RCP21	Receptacle, 250V/15A	2 EA
52TS20	Pwr. Dist. Block, 2 pole,	2 EA
56FUS14	Fuse 15A 250V	2 EA
56FUS15	Fuse, 3A 250V 3AG Slow Blow	1 EA
56FUS16	Fuse, 1/2A 250V 3AG Slow Bl	1 EA
56FUS20	Fuse, 20A 250V, Slow Blow 3	2 EA
56FUS38	Fuse, 30A 500V SlowBlow	4 EA
62D2483A00	Blower, 50 Hz 220V~	1 EA
62D331A	Voltage Selector Assembly	1 EA
55SW26	Switch, 3PDT, 250V, 10A	1 EA
64VS409	Assembled Voltage Sel	1 EA
64CT464	PCB Assy Control AP 30	1 EA
<b>62D3202A00</b>	Assy,Ctl Bx 8K 220V~ 50Hz	1 EA
16D2641A00	Harness, Cntrl Bx	1 EA
16D3208A00	Harness, Cntrl Bx -GTools	1 EA
31MSC02	Motor, speed control-KB	1 EA
32PSF01	Power Supply, Open Frame, 1	1 EA

Part Number	Description	Qty. per unit
32TRC01	Autoformer 208-240V~	1 EA
33RLY20	Relay, 12VDC, Chassis	1 EA
44CPG08	Plug,plastic,black 1.5"	3 EA
44RUB03	Grommet,Continuous .06	FT
52FUH04	Fuse Holder, 3AG/3AB	4 EA
52FUH08	Fuseholder, 3AG, .25 Tab	2 EA
52RCP21	Receptacle, 250V/15A	2 EA
52RCP24	Receptacle, 250V/50A	2 EA
52TS20	Pwr. Dist. Block, 2 pole,	2 EA
56FUS14	Fuse 15A 250V	2 EA
56FUS15	Fuse, 3A 250V 3AG Slow Blow	1 EA
56FUS16	Fuse, 1/2A 250V 3AG Slow Blow	1 EA
56FUS20	Fuse, 20A 250V, Slow Blow 3	2 EA
62D2483A00	Blower, 50 Hz 220V~	1 EA
62D331A	Voltage Selector Assembly	1 EA
55SW26	Switch, 3PDT, 250V, 10A	1 EA
64VS409	Assembled Voltage Sel	1 EA
<b>62D3558A00</b>	Assy,Ctl Bx 8K 480VCLS GT	1 EA
16D3074A00	Harness, Control Box	1 EA
16D3208A00	Harness, Cntrl Bx -GTools	1 EA
16D3455A00	Harness , CT Box - Closed	1 EA
16D3878A00	Harness, cntrl bx suppl	1 EA
31MSC02	Motor, speed control-KB	1 EA
32PSF01	Power Supply, Open Frame, 1	1 EA
32TRC01	Autoformer 208-240V~	1 EA
33RLY20	Relay, 12VDC, Chassis	1 EA
44RUB03	Grommet,Continuous .06	0 FT
52FUH04	Fuse Holder, 3AG/3AB	6 EA
52FUH07	Fuse Block- 13/32 x 1.5 4	1 EA
52FUH08	Fuseholder, 3AG, .25 Tab	2 EA
52RCP20	Receptacle, 125V/20A	2 EA
52RCP21	Receptacle, 250V/15A	2 EA
52RCP24	Receptacle, 250V/50A	2 EA
52TS19	Power Dist.Block 3 pole 4	2 EA
56FUS04	Fuse, 5A/250V Slow BI 3AG	2 EA
56FUS14	Fuse 15A 250V	2 EA
56FUS15	Fuse, 3A 250V 3AG Slow Blow	1 EA
56FUS16	Fuse, 1/2A 250V 3AG Slow BI	1 EA

<b>Part Number</b>	<b>Description</b>	<b>Qty. per unit</b>
56FUS20	Fuse, 20A 250V, Slow Blow 3	2 EA
56FUS38	Fuse, 30A 500V SlowBlow	4 EA
62D2483A00	Blower, 50 Hz 220V~	1 EA
62D331A	Voltage Selector Assembly	1 EA
55SW26	Switch, 3PDT, 250V, 10A	1 EA
64VS409	Assembled Voltage Sel	1 EA
<b>62HF1-2-60</b>	Exhaust System 230V~ 60Hz	1 EA
49DCT04	Ducting, Alum 4" diam.	1 EA
52CTP21	Plug 250V~ 15A	1 EA
54CAB05	Cable,Int'l 18 Ga	10 FT
62BA	HF1 Beau Tap Bkt Assemble	1 EA
62BLO02	Assembled HF1 Blower	1 EA
64VB412V02	HF1 Variable blower ctrl	1 EA
<b>62MFA01</b>	Mylar frame assembly	2 EA
13D4470A00	Sheet mylar,.004 Thk	1 EA
62MFI01	Mylar frame, inner	1 EA
11D4302A62	Latch	12 EA
41-08WSP	NSI Spring Washer	24 EA
41B04PPS.37	NSI 4-40 x 3/8 Phil Pan Ms	12 EA
41B04WFR	#4 Flat Black Washer	12 EA
44WFN01	NSI Nylon Washer	24 EA
62MFIA01	Mylar frame inner assembly	1 EA
11D4307A07	Bracket, right angle 02	4 EA
12D4471A76	Frame mylar inner fr/r	2 EA
12D4472A76	Frame mylar inner side	2 EA
81TAP16	Tape Glide (Black UHMW)	1 RL
81TAP25	Tape blue.015"x.50"x10'R1	10.5 FT
62MFO01	Mylar frame, outer	1 EA
11D2971A71	Mount, Magnetic	1 EA
12D2389A76	Base, Handle/Latch	2 EA
12D2390A76	Mount,Handle -Latch	2 EA
12D2391A76	Latch-Latch Handle	2 EA
12D2476A00	Ball Stud, Shortened, Gas	2 EA
43SPR12	Spring 7/16 x 9/16 Compr.	2 EA
44HDL03	Handle, 6". Alum	1 EA
62MFOA01	Mylar frame outer assy	1 EA
11D4306A07	Bracket right angle	4 EA
12D4473A76	Frame mylar outer front	1 EA

Part Number	Description	Qty. per unit
12D4474A76	Frame mylar outer rear	1 EA
12D4475A76	Frame mylar outer side	2 EA
81TAP25	Tape blue.015"x.50"x10'Rl	10.5 FT
<b>62PUM01</b>	Assy, Pump, 220V 60Hz	2 EA
11D1633A02	Plate Pump	1 EA
13D2170	Rubber Washer	4 EA
16D2741A00	Cable, Vac Pump	1 EA
39VAP05	Vacuum Pump 230V~ 60 Hz	1 EA
<b>62CL54</b>	5kW 208/240V~ 60Hz Power Supply	1 EA
11D0932A02	Cover, AL54	1 EA
16D0277A00	Harness, 5K Power Supply	1 EA
16D1045A00	Harness, Beau Plug	1 EA
16D1585	Interlock Harness	1 EA
32BAL01	Ballast	4 EA
32TRC01	Autoformer 208-240V~	1 EA
33RLY02	Contactora, 2 pole,NO,30Amp	1 EA
33RLY04	Relay, Sealed	2 EA
39BLO23	Blower, mdl ball bearing	1 EA
52FUH04	Fuse Holder, 3AG/3AB	1 EA
54PWR01	Power Cable for AL53	1 EA
56FUS15	Fuse, 3A 250V 3AG Slow Blow	1 EA
62D1047	Voltage Selector 60Hz	1 EA
55SW26	Switch, 3PDT, 250V, 10A	1 EA
64VS409-HA	Voltage Selection Board	1 EA
62D1048	Capacitor Assembly 60 Hz	1 EA
64MV407V03	Assy UV Lt Ctrl 5K 60Hz	1 EA
<b>62CL54-480</b>	5kW 480V~ 60Hz Power Supply	1 EA
11D0932A02	Cover, AL54	1 EA
16D0277A00	Harness, 5K Power Supply	1 EA
16D1045A00	Harness, Beau Plug OEM	1 EA
16D1585	Interlock Harness	1 EA
32BAL01	Ballast	4 EA
33RLY02	Contactora, 2 pole,NO,30	1 EA
33RLY04	Relay, Sealed	2 EA
39BLO23	Blower, mdl ball bearing	1 EA
44LEG03	Leveling Glide, Non-Skid-Sw	4 EA
44RUB11	Grommet,Continuous .085	1.250 FT
51WRN07	NSI Wire crimp nut	6 EA

<b>Part Number</b>	<b>Description</b>	<b>Qty. per unit</b>
54PWR01	Power Cable for AL53	1 EA
54PWR05	Pwr Crd 18/3 SJT 12'	1 EA
62D3654A00	Assy, Capacitor AL54-480	1 EA
64MV407V03	Assy UV Lt Ctrl 5K 60Hz	1 EA
<b>62CL64</b>	5kW 220V~ 50Hz Power Supply	1 EA
16D0277A00	Harness, 5K Power Supply	1 EA
16D1045A00	Harness, Beau Plug OEM	1 EA
16D1585	Interlock Harness	1 EA
32BAL03	Ballast	4 EA
32TRC01	Autoformer 208-240V~	1 EA
33RLY02	Contactora, 2 pole,NO,30	1 EA
33RLY04	Relay, Sealed	2 EA
39BLO23	Blower, mdl ball bearing	1 EA
44LEG03	Leveling Glide, Non-Skid-Sw	4 EA
44RUB11	Grommet,Continuous .085	1.250 FT
52FUH04	Fuse Holder, 3AG/3AB	1 EA
54CAB10	Cable, 3x 4.0MM2 black-rubb	8 FT
56FUS15	Fuse, 3A 250V 3AG Slow Blow	1 EA
62D1046-64	Capacitor Assembly 50Hz	1 EA
64MV407V01	Assy UV Lt Ctrl 5K 50Hz	1 EA
<b>62LHSE-SW</b>	Lamphead 5kW SE-SW	1 EA
L1261	Lamp L1261	1 EA
PA91	PA91 photocell assembly	1 EA
90RF53-SW	Reflector	2 EA
63D0142B00	Lamp Support Assy	2 EA
12D1361	Shutter Chain	1 EA
12D1577	Spring, Idler-5K Shutter	1 EA
12D1997A99	Sprocket, Shutter Motor	1 EA
16D0180A00	K-Harness, Lamphead 5 K	1 EA
18D319	Glass, Frosted Diffuser for Photocell	1 EA
31MOT06	Motor, AC Gear Positive	1 EA
39BLO23	Blower, mdl ball bearing	2 EA
45KOB05	Knob, Glass. Carriage	2 EA
55SW02	Switch, Shutter Timing	1 EA
55SW03	Switch, GlassInterlock	1 EA
56THM01	Thermostat, model K	2 EA
62SASE-SW	5K Supper Wide Shutter	1 EA
63D3669B00	Idler arm ass'y	1 EA

Part Number	Description	Qty. per unit
11D3605A62 0	Bracket Idler-Shutter Ay	1 EA
12D700	Sprocket 10 Tooth .250	1 EA
41-06NHX	NSI 6-32 Hex Nut Zinc	1 EA
41-06SBL.62	NSI 6-32x5/8 Shoulder Bolt	1 EA
41B10WFR	NSI #10 Flat Washer Black	1 EA
43BLB15	Bearing, Flanged .187 I.D	2 EA
64TR408V00	PCB Trigger	1 EA
<b>62CL84</b>	8kW 60Hz 208/240V~ Power Supply	2 EA
16D1045A00	Harness, Beau Plug OEM	1 EA
16D1585	Interlock Harness	1 EA
16D2617A00	Power Cable, AL54-8K P/S	1 EA
16D2629A00	Harness, 8K-B P/S - MAIN	1 EA
32BAL01	Ballast	4 EA
32TRC08	Autoformer 208/225/240V~	1 EA
33RLY02	Contact, 2 pole,NO,30	1 EA
33RLY04	Relay, Sealed	2 EA
39BLO23	Blower, mdl ball bearing	1 EA
44RUB11	Grommet,Continuous .085	1.25 FT
52FUH04	Fuse Holder, 3AG/3AB	1 EA
56FUS15	Fuse, 3A 250V 3AG Slow Blow	1 EA
62D1047	Voltage Selector 60 Hz AL	1 EA
55SW26	Switch, 3PDT, 250V, 10A	1 EA
64VS409-HA	Voltage Selection Board	1 EA
62D2652A00	Assembly, Capacitor	1 EA
64MV407V24	Prnt Light Ctrl PCB w/Min	1 EA
<b>62CL84-480</b>	8kW 60Hz 480V~ Power Supply	2 EA
16D1045A00	Harness, Beau Plug OEM	1 EA
16D1585	Interlock Harness	1 EA
16D2617A00	Power Cable, 8K P/S	1 EA
16D2629A00	Harness, 8K-B P/S - MAIN	1 EA
32BAL01	Ballast	4 EA
33RLY02	Contact, 2 pole,NO,30	1 EA
33RLY04	Relay, Sealed	2 EA
39BLO23	Blower, mdl ball bearing	1 EA
44LEG03	Leveling Glide, Non-Skid-Sw	4 EA
44RUB11	Grommet,Continuous .085	1.25 FT
52FUH04	Fuse Holder, 3AG/3AB	1 EA
54PWR05	Pwr Crd 18/3 SJT 12'	1 EA

<b>Part Number</b>	<b>Description</b>	<b>Qty. per unit</b>
56FUS15	Fuse, 3A 250V 3AG Slow Blow	1 EA
62D3533A00	Assy, Capacitor 60H,480V	1 EA
64MV407V24	Prnt Light Ctrl PCB w/Min	1 EA
<b>62CL94</b>	8kW 50Hz 220V~ Power Supply	2 EA
16D1045A00	Harness, Beau Plug OEM	1 EA
16D1585	Interlock Harness	1 EA
16D2617A00	Power Cable, 8K P/S	1 EA
16D2629A00	Harness, 8K-B P/S - MAIN	1 EA
32BAL01	Ballast	4 EA
32TRC08	Autoformer 208/225/240V~	1 EA
33RLY02	Contactactor, 2 pole,NO,30	1 EA
33RLY04	Relay, Sealed	2 EA
39BLO23	Blower, mdl ball bearing	1 EA
44RUB11	Grommet,Continuous .085	1.25 FT
52FUH04	Fuse Holder, 3AG/3AB	1 EA
56FUS23	Fuse, 4 Amp 250V Slo-BLo	1 EA
62D2723A00	Assembly, Capacitor	1 EA
64MV407V22	Prnt Light Ctrl PCB w/Min	1 EA





## 17. Warranty

---

OLEC

### Limited Warranty

OLEC equipment is warranted against defects in material for ONE (1) Year from date of purchase. Faulty parts will be repaired, replaced, or purchase price refunded at OLEC's option, for the original Buyer, provided the parts have been replaced by authorized personnel and are returned prepaid to the OLEC factory in Irvine, CA. Shipment must be accompanied by proof of purchase and the Dealer/Distributor name.

This Warranty applies only to equipment which was installed and used according to instructions and in the way it was intended to be used by the manufacturer. Unauthorized repairs, use of non-OLEC parts and lamps, modification, or Serial Numbers that have been removed or defaced, void this Warranty. Glass parts are not included in this Warranty. Lamps are covered according to the Warranty below.

The OLEC Corporation and/or the Seller shall not be liable for any loss, damage or injury arising out of the improper use of, the failure of, or the inability to use the equipment. It is the Buyer's responsibility to ascertain the suitability of the equipment for the application. The Buyer assumes all risk and responsibility for the proper installation, for reading the Instruction Manual and retaining it with the equipment for the safe use of the OLEC product. All operators must be made familiar with the proper use and safe operation upon installation and periodically thereafter.

No one is authorized to assume any obligation, either on behalf of the OLEC Corporation or the Seller, which is not in accordance with the above.

### Lamp Warranty

Should any original OLITE Lamp fail prematurely when used in OLEC lights, it should be returned promptly to OLEC, prepaid. It should be accompanied by proof of purchase, explanation of the type of failure incurred, and the approximate useful life of the lamp prior to failure. If it is determined by OLEC that the failure or shortened life has been caused by faulty material or workmanship, full or partial replacement will be extended to the Buyer.

**IMPORTANT:** The use of any lamp, other than those purchased or approved by OLEC will void this Warranty.

*All Warranty Service should be handled through the Distributor  
through whom the equipment was purchased.*



Corporation

17112 Armstrong Avenue, Irvine Ca U.S.A. 92614  
U.S.A. (949) 399-6500 Fax (949) 399-6501