

ADVANCED DIRECT IMAGING

by **ALTIX**



DIRECT IMAGING WITH US

Direct Imaging Solution for PCB, FPCB, PCM (...)

ADVANCED DIRECT IMAGING by ALTIX

Enhanced 4 LEDs Photo Heads for Higher Productivity and Printing Quality

Advanced High Resolution DMD System

Fully Intuitive Human Machine Interface

From Conventional Dry Films to Ink and Solder Resists



Real Time Panel Dynamic Scaling and Partitioning

Low Power Consumption

Compact Footprint: All in One Built-In System

Minimum Service Maintenance Required

High Accuracy Registration System

Best in Class Side to Side Registration

Panels Held Down by Vacuum Table and/or Clamping System

Rigid and Flex PCB Smooth Handling

ADIX Specifications

Panel	Panel size	From 228 x 254mm up to 610 x 762mm From 9"x10" up to 24"x30"		
	Panel thickness	0.04 to 6mm 1.6 to 236mils		
	Warp and twist	0.04 to 0.8mm 1.6 to 31mils \times panel thickness: 1% of the diagonal 0.8 to 6mm 31 to 236mils \times panel thickness: 0.5% of the diagonal		
	Weight	6kg max (13.22lbs)		
Web	Image size	From 190mm x 190mm (7.5"x7.5") up to 610mm x 685mm (24"x27")		
	Web Thickness	0.030 to 0.5mm		
		Adix SA		Adix SA neo
Imaging	Resolution - L/S	10/10 μ m 0.4/0.4mil ⁽¹⁾	20/20 μ m 0.8/0.8mil ⁽¹⁾	30/30 μ m 1.2/1.2mils ⁽¹⁾
	Resolution - DAM	NA	25 μ m 1mil	50 μ m 2mils
	Edge Roughness	\pm 0.5 μ m	\pm 1.5 μ m	\pm 3 μ m
	Depth of Focus	100 μ m	200 μ m	400 μ m
	Autofocus	\pm 8mm \pm 315mils		
	Image to panel registration	\pm 8 μ m \pm 0.31mil		
	Side to side registration	\pm 12 μ m \pm 0.47mil		
Throughput	Exposure time	14s with 30mJ/cm ² resist for 457 x 610mm (18"x 24") image size (6 heads) ⁽²⁾		
Process	Imaging resist materials	Conventional dry films or specific for DI \times Ink & solder resists		
	Resist sensitivity	From 10 to 1,250mJ/cm ² and above		
	Exposure spectrum	4 wavelengths per Photo Head: 365/380/395/405nm		
	Applications	PCB \times FPCB / Flex \times Photo Chemical Milling \times IC Substrate \times Touch Panel		
	Production types	Inner Layers \times Outer Layers \times Soldermask (PSR)		
Graphic User Interface	Altix Direct Imaging Suite™	22 » touch screen, intuitive software, SPC capabilities, multilanguage		
	Data Input	Extended Gerber, ODB++, (others upon request)		
General utilities & Foot print	Data Input	Extended Gerber, ODB++, (others upon request)		
	Air supply	6 bars 1.5m ³ /min		
	Water supply	Water pressure 3~5 bars \times Flow rate: 23l/min @ 12°C or 33l/min @ 14°C		
	Machine weight	3,500kg (7,716lbs)		
	Dimensions	L : 2,870mm (113") W: 1,750mm (69") H : 1,870mm (74")		

(1) depending on photoresist, surface preparation & DES process • (2) estimated time given as reference but can fluctuate according to the process adjustments

Imaging with us!

ADIX Semi-Automatic & Fully-Automatic Direct Imaging Product Range



Adix SA **Semi-Automatic** **Panel to Panel DI Exposure**

Semi-Automatic Direct Imaging solution for QTA, high-mix low and medium volume production dedicated for all processes: Inner Layers, Outer Layers and Soldermask (PSR)



Adix SA neo **Semi-Automatic** **Panel to Panel DI Exposure**

Adix SA neo is the Fastest Imaging System with Customized Number of Photo Heads & Stripes. From 1 to 7 Photo Heads and upgradable on site. It is dedicated for all processes.

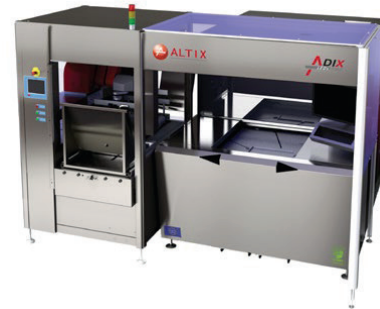

Adix CS / F **Compact Standardized / Flip** **Compact - Island of Automation Fully** **Automatic Double Side**

The system is designed to automatically load and unload panels into an Adix Direct Imaging system from either angular or slot cassettes.

An automatic flip & cleaning functions are integrated. The system is able to handle multiple batches and different panel sizes.

This compact automation is dedicated for all resists: dry film & solder resists and upgradable on site.

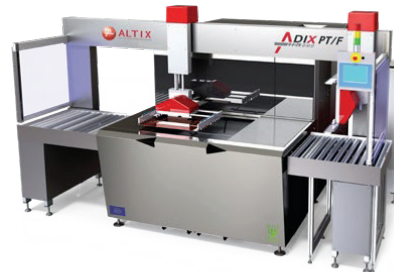

Adix PT / F **Pass-Through / Flip** **In-Line Automation** **Fully Automatic Double Side**

Integrated automation for fully-automatic Direct Imaging process in-line or island of automation.

Pass-through double-sided production with « in the air » flip.

This compact automation is dedicated for all resists: dry film & solder resists and upgradable on site.

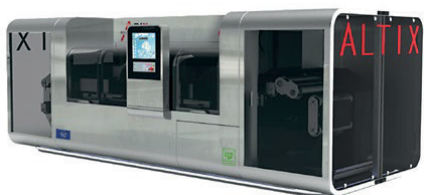

Adix RtR **Roll to Roll DI Exposure** **Fully-Automatic**

Adix Roll to Roll is a fully automatic Direct Imaging designed as a single sided Roll to Roll exposure system for fine line resolution, tight registration and high throughput capabilities.

It can handle all types of web for Flex Printed Circuit Boards, Photo Chemical Milling, Touch Panel, Thin Film Photovoltaic, etc...

ADIX Advanced Features

ALDS-Power4+™

Advanced high power LEDs with high resolution DMD System. The heart of the system is a creative combination of 4 high-density LEDs light sources through a unique optical device coupled to a high frequency (up to 20kHz) DMD coordinated with a graphic signal and projection lens.

This combination enables our ADIX solution to perform high-resolution line and space down to 10µm.

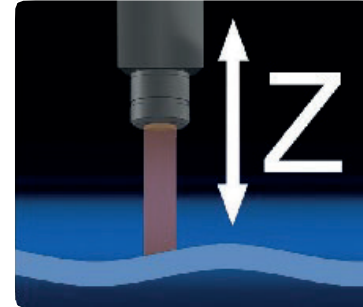
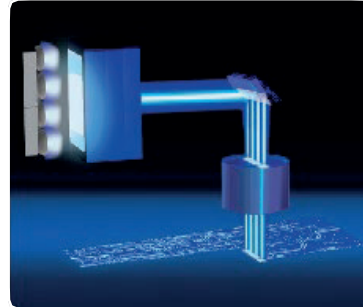

High Dynamic Autofocus Function

Highly precise and dynamic autofocus system is integrated inside each imaging head. The heads get real time feedbacks in order to take into account the warping and surface thickness variations of the board at ±8mm.

This state of the art tool plus the depth of focus of the head, which allows imaging in a consistently suitable state, drastically reduce the occurrence rate of imaging errors.

ALDS-Power4+™

Highly accurate real time scaling and distortion compensation technology responds to the PCB material variations. Each digital image can be scaled to match with the panel distortion.

For each panel, different scale factors can be applied with dynamic imaging modes: linear (Trapezoidal scaling, Orthogonal scaling) and non-linear (Polygonal scaling).

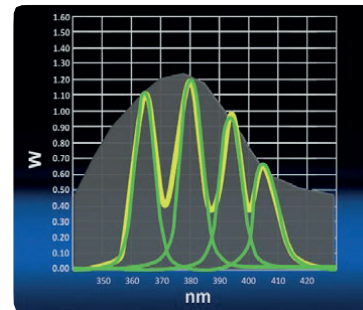
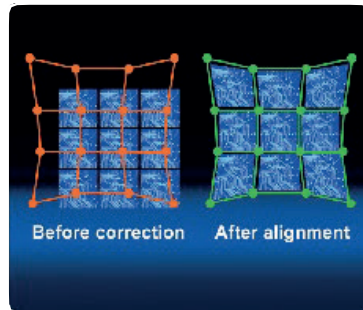

Multi-Wavelengths UV-LED

The combination of different UV light wavelengths enables to polymerize a large range of dry film, ink and solder resists.

With 4 LED wavelengths (365/380/395/405nm) and by adjusting the output ratio, it is possible to obtain the most efficient and fast printing for each type of dry resists or soldermask. UV-LED consumes less energy, generates less heat, and lasts much longer than typical laser diode or blue laser based on light sources.

High Accuracy Registration

A multiple CCD cameras vision system enables featuring image to panel registration down to ±8µm for high-end HDI designs.

Our solution can align the panel via a through hole or various alignment marks.

Our side-to-side registration for inner layers enables high accuracy alignment down to ±12µm thanks to our exceptional registration system with adjustable points fitting the panel size.

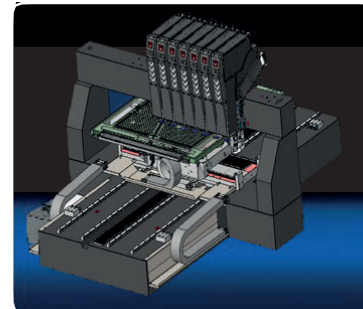
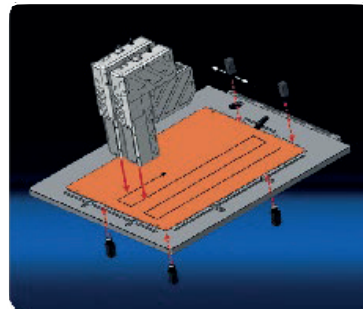

Number of Light Engines depending on your capacity. Upgradable on site

Our modular and flexible imaging technology ALDS-Power4™ can be adapted to your throughput requirements. Also, the number of Photo Heads can be chosen accordingly when defining your new Direct Imaging equipment. This number of Photo Heads can be enlarged from 1 to 7 anytime in the future to match with your expanding needs.

This incremental investment enables to have a fully optimized system, which means a quicker Return Of Investment.

Smart Vacuum & Clamping Technology™

A unique Vacuum & Clamping mechanism offers an automatic selectable vacuum system.

Vacuum and clamping are automatically monitored according to the panel size.

This clamping system can safely hold warped PCBs and handle panel thickness from 40µm to 6mm.

In addition, with the autofocus function, it allows a perfect imaging compared to other systems having only a vacuum table without clamping mechanism.

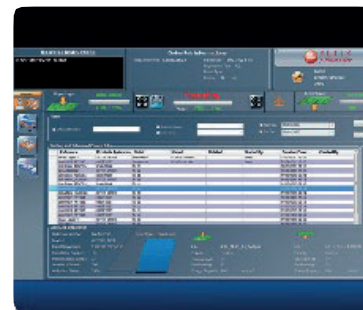
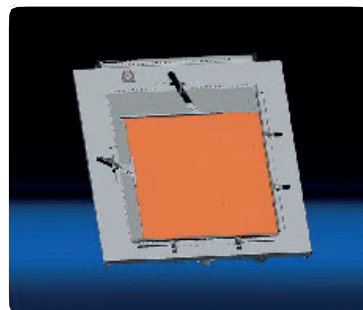

Human Machine Interface (HMI)

Fully intuitive interface enables a friendly-user utilization for the operators. A state of the art touch screen graphical user interface enables an easy operating such as: quick job setups, parameters monitoring, full diagnosis, or process optimization.

Our powerful software "ALIX Direct Imaging Suite™" offers more with multilingual capabilities and our statistical module "Altix Statistical Process Control Module".

ALTIX, over 30 years of innovations and performances!



Direct Imaging & Contact Printers



Email: kawa@kawa-gmbh.com



Imaging with us!



www.altix.fr
www.kawa-gmbh.com

Light Engines

LedLight™ MACH5 2019

2019

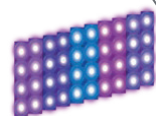

ALDS-Power4+™ 2018

2018

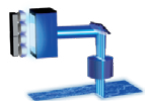

LedLight™ MACH3 2017

2017

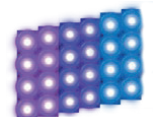

ALDS-Power4™ 2016

2016

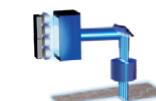

ALDS 2015

2015



LedLight™ 2012

2012

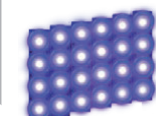

OptiLight™ 2009

2009

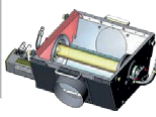

Diffuse™ 1997

1997

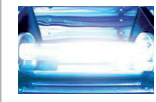

ColliLight™ 1993

1993



Timeline Product Launch



2019 Adix SA neo
Adix RtR

2018 Adix CS / F
Adix PT / F

2017 Afosa LedLight Mach3
Acura LedLight Mach3

2016 Acura Premium

2015 Adix SA

2014 AcuReel

2013 Afosa Led

2012 Acura DSS

2011 Acura LedLight

2007 Acura

2005 Arrow

2002 Afosa ie

1996/98 Evol2b
Evol2b RtR

1993 Evolution 1